

# Automatic Test System ATS 400

## Instruction Manual Base device with SC-NG



<b>1</b>	<b>Table of Contents</b>	<b>2</b>
<b>1</b>	<b>Table of Contents</b>	<b>2</b>
<b>2</b>	<b>Safety</b>	<b>5</b>
<b>2.1</b>	<b>Used Symbols</b>	<b>5</b>
<b>2.2</b>	<b>Qualification of Staff</b>	<b>5</b>
<b>2.3</b>	<b>Fundamental Safety Notations</b>	<b>6</b>
<b>2.4</b>	<b>Responsibility and Warranty</b>	<b>6</b>
<b>2.5</b>	<b>Damage by Transport</b>	<b>6</b>
<b>3</b>	<b>General Information</b>	<b>7</b>
<b>3.1</b>	<b>Safety Information</b>	<b>7</b>
<b>3.2</b>	<b>Brief Description of the Product</b>	<b>7</b>
<b>3.3</b>	<b>Model and Type Designation</b>	<b>8</b>
<b>3.4</b>	<b>Validation</b>	<b>8</b>
<b>3.5</b>	<b>Handling according to Regulations</b>	<b>8</b>
<b>3.6</b>	<b>Maintenance work</b>	<b>8</b>
<b>3.7</b>	<b>Scope of Delivery</b>	<b>8</b>
<b>3.8</b>	<b>Terms and definitions</b>	<b>9</b>
<b>4</b>	<b>About the Test System</b>	<b>10</b>
<b>4.1</b>	<b>Operating Components at the Front Side (all Types)</b>	<b>10</b>
4.1.1	Main Switch	10
4.1.2	Multifunctional Rotary Switch „Navigation Plus“	10
4.1.3	Keyboard Foils	10
4.1.4	LED Display	11
4.1.5	Display	12
<b>4.2</b>	<b>Equipment and Control Types</b>	<b>12</b>
4.2.1	PREMIUM LINE X2: The Remote Type	12
4.2.2	PREMIUM LINE X4: The Stand-Alone Type	12
4.2.3	PREMIUM LINE X6: The PC-Inside Type	13
4.2.4	PREMIUM LINE X8: The High-End Type	13
<b>4.3</b>	<b>Back Side with Interfaces</b>	<b>14</b>
4.3.1	ETL-Interface for Selection and Operation Panels	15
4.3.2	User-Interface: Free configurable IOs (optional article 201327)	16
4.3.3	Common specification	17
4.3.4	ADF-Interface: Analogue IOs und Frequency Inputs (optional article 202734)	17
4.3.5	RS232-Interface	18
4.3.5.1	PC-Connection	18
4.3.5.2	Log Printer-Connection via a simple ASCII-Output	18
4.3.5.3	PC- or PLC-Connection via a simple ASCII-Protocol	18
4.3.6	CAN 1: Interface for the Extension of the Test System	18
4.3.7	CAN 2: Interface for customer-specific solution	19
4.3.8	HV-Connections: HV-Connection Jack, double pole, HVS06C by ETL:	19
4.3.9	Connection for a PE-Probe Tip (Protective Earth CPonductor-Test Probe):	19
4.3.10	Safety circuit and warning lamp combination	20
4.3.11	Earthing	20
4.3.12	System connector 10 pole	20
4.3.13	System connector 12 pole	21

<b>5</b>	<b>Information for safe Operation .....</b>	<b>22</b>
<b>5.1</b>	<b>General Safety Information .....</b>	<b>22</b>
<b>5.2</b>	<b>Special Safety Information for High Voltage Testing and other dangerous Kinds of Testing .....</b>	<b>22</b>
5.2.1	Testing with High Voltage Test Pistols .....	22
5.2.1.1	Fusing the Work Place .....	22
5.2.1.2	Protecting Outsiders.....	22
5.2.1.3	Protecting the Test Person .....	22
5.2.2	Testing with a Safety Test Cage.....	23
5.2.2.1	Fusing the Work Place .....	23
<b>6</b>	<b>First Steps, Commissioning.....</b>	<b>24</b>
<b>7</b>	<b>Safety circuit .....</b>	<b>25</b>
<b>7.1</b>	<b>Basic principles.....</b>	<b>25</b>
<b>7.2</b>	<b>Safety parameters .....</b>	<b>26</b>
<b>7.3</b>	<b>Pin numbering of the sockets .....</b>	<b>26</b>
<b>7.4</b>	<b>Socket warning lamp combination .....</b>	<b>26</b>
7.4.1	Plug with cable .....	27
<b>7.5</b>	<b>Socket safety circuit .....</b>	<b>28</b>
7.5.1	Plug with cable .....	28
7.5.2	Configuration 0: No connection.....	28
7.5.3	Configuration 1: Two hand appliance.....	29
7.5.4	Configuration 2: Protective door / test cage with 2 closers .....	30
7.5.5	Configuration 3: Protective door / test cage with antivalent contacts.....	31
7.5.6	Configuration 4: Protective door automation solution .....	32
7.5.7	Configuration 5: Check with test pistol .....	33
7.5.8	Configuration 6: Smart switch .....	34
7.5.9	Configuration 7: Protective door with guard locking and 2 NO contacts.....	35
7.5.10	Configuration 8: Protective door with guard locking, potential-free antivalent contacts .....	36
7.5.11	Configuration 9: Protective door with OSSDs.....	37
<b>7.6</b>	<b>LED SAFETY CIRCUIT .....</b>	<b>38</b>
<b>7.7</b>	<b>Message in ETL DataView 3 .....</b>	<b>38</b>
<b>7.8</b>	<b>State in ETL DataView 3.....</b>	<b>38</b>
7.8.1	Tab page Status SHK.....	39
7.8.2	Tab page Detail 1 .....	40
7.8.3	Tab page Detail 2 .....	41
7.8.4	Tab page Detail 3.....	42
7.8.5	Tab page Debug.....	43
<b>7.9</b>	<b>Accessories.....</b>	<b>43</b>
7.9.1	Accessories for configuration 1 .....	44
7.9.2	Accessories for configuration 4 .....	44
7.9.3	Accessories for configuration 5 .....	44
7.9.4	Accessories for warning lamp combination .....	44
<b>8</b>	<b>Operation.....</b>	<b>45</b>
<b>9</b>	<b>Display of LED Error.....</b>	<b>46</b>
<b>9.1</b>	<b>Sequence of the blink code .....</b>	<b>46</b>
<b>9.2</b>	<b>Meaning of the blink codes .....</b>	<b>46</b>

9.2.1	Loss of communication with the LT-CPU.....	46
9.2.2	Failure of the power converter.....	46
9.2.3	Overtemperature.....	47
9.2.4	Loss of communication with the HMP.....	47
9.2.5	Loss of communication with the MEP function.....	47
9.2.6	Loss of communication with the MEP insulation test.....	47
9.2.7	Loss of communication with the MEP protective earth test.....	47
9.2.8	Loss of communication with the safety circuit.....	48
9.2.9	Loss of communication with the front.....	48
9.2.10	Loss of communication with the 2. Userinterface.....	48
9.2.11	Loss of communication with the ATM 400.....	48
9.2.12	Loss of communication with an external electronic source.....	49
9.2.13	Loss of communication with the adjustable transformer.....	49
9.2.14	Loss of communication with the external source.....	49
9.2.15	Loss of communication with a matrix module.....	49
<b>10</b>	<b>Settings of the ETL Interface.....</b>	<b>50</b>
<b>10.1</b>	<b>Standard setting.....</b>	<b>50</b>
<b>10.2</b>	<b>Enabled.....</b>	<b>51</b>
<b>10.3</b>	<b>Button Start.....</b>	<b>52</b>
<b>10.4</b>	<b>Time.....</b>	<b>53</b>
<b>10.5</b>	<b>Safety circuit.....</b>	<b>55</b>
<b>10.6</b>	<b>Using the Buzzer.....</b>	<b>56</b>
<b>10.7</b>	<b>Disable SC, Con.....</b>	<b>56</b>
<b>10.8</b>	<b>KeepPolarity.....</b>	<b>56</b>
<b>10.9</b>	<b>Hold matrix at start with contacting.....</b>	<b>56</b>
<b>10.10</b>	<b>Warn lamp flashing.....</b>	<b>56</b>
<b>10.11</b>	<b>Adaptive HV timing.....</b>	<b>56</b>
<b>10.12</b>	<b>Turn off analog output.....</b>	<b>58</b>
<b>11</b>	<b>Technical support.....</b>	<b>59</b>
<b>12</b>	<b>Technical Data.....</b>	<b>60</b>
<b>12.1</b>	<b>General Technical Data.....</b>	<b>60</b>
<b>12.2</b>	<b>Measurement modules, technical data.....</b>	<b>61</b>
<b>13</b>	<b>Manufacturer's Declaration / EU-Declaration of Conformity.....</b>	<b>62</b>
<b>14</b>	<b>Warranty.....</b>	<b>63</b>
<b>15</b>	<b>Personal Notes.....</b>	<b>64</b>
<b>16</b>	<b>Appendix A SC-NG error numbers.....</b>	<b>65</b>

## 2 Safety

### 2.1 Used Symbols



#### **WARNING**

Information to prevent extensive material and ecological damage.



#### **CAUTION**

Information on handling and usage. Disregard may lead to malfunctioning or marginal material damage. Information to prevent extensive material and ecological damage.



#### **DANGER**

Information to prevent all kinds of personal damage.



#### **ANNOTATION**

Information to accentuate operating instructions.



#### **TIP**

Tips for the handling of the system or the operation.



#### **INITIAL COMMISSIONING**

Information on actions and data which are necessary for the initial commissioning of the system.

### 2.2 Qualification of Staff



#### **PROFESSIONAL STAFF**

The operations described in this document are only allowed to be realized by persons who have the qualified technical formation or have been trained appropriately by the operator.

## 2.3 Fundamental Safety Notations

- All operations are only allowed under consideration of the relevant prescriptions and observance of the protective measures.
- Consider additionally the safety notations given in this document.

Pass on the safety notations to all other users.

## 2.4 Responsibility and Warranty

ETL Prüftechnik does not accept responsibility and warranty if the operator or a third party:

- Disregard this document
- Do not use the product according to regulations
- Make any kind of intervention (alteration, modification, etc.) at the product
- Use the product with supplies which are not listed in the corresponding product documentation

The responsibility related to the used process media lies with the operator.

## 2.5 Damage by Transport



### CAUTION

#### **Avoid transport damage!**

These devices must be transported on a pallet by a forwarding.

## 3 General Information

The existing testing device is build according to EN 61010-1, tested and has left the factory in a perfect safety-related state.

### 3.1 Safety Information



**DANGER**

To guarantee a riskless operation, the operator has to regard the advice and warnings given in this instruction manual and in the EN 50191 (DIN VDE 0104).

The testing system is bound to be used in the interior spaces and is only allowed to be used as a testing device to test the electric safety.

When installed in a special device suitcase of the series 400, the device can also be used outdoors, but it has to be protected from splashing water.

### 3.2 Brief Description of the Product

You have bought a high-quality CE Testing System to check the electric safety of electrotechnical products.

If vacuum cleaner, blow drier, machine tool, transformer or contact terminal – our testing devices and automatic testing machines ensure their efficiency and process reliability by a well thought out control concept and a future-oriented concept to bind all testing devices and testing systems on today's and tomorrow's information technology. of course they are adapted to all usual norms and standards worldwide.

Depending on the test object and the number of pieces and cycles, the devices can be employed in manual test locations and likewise as a semi- or fully automatic component in the production. In the automatic operation all the measuring paths are connected with the test object via a relay matrix.

The favoured (sensible) combination is freely programmable.

#### **High Reliability**

Our testing devices are said to be particularly robust and suitable for daily use and are in action all over the world- often second by second and not rarely for 10 – 20 years.

#### **Good Operability**

Unified and well thought out controlling philosophies ensure a quick and unproblematic access to the actual testing task – guaranteed without a manual as well.

#### **Security, Economic Efficiency and Precision**

Everything that can be done for the safety of the operation personnel, the measurement precision, the throughput rate and the process security is consequently incorporated in ETL products. So at ETL the most expensive safety technology as well as functions to prevent the test object from damage and increase the process reliability are never expensive extras, but generally available in the standard delivery (positively driven safety relays, contacting surveillance, ramp function, residual voltage surveillance, ...).

#### **Open designed interfaces- guaranteed Flexibility and Transparency**

The connection happens via PLC and in the Series 400 additionally PC or driver. All test parameters then accommodate automatically.

Furthermore the Interfaces make permanent collection of data and the download of sets of test parameters as well as the control of operating parameters possible. On the PC the data management software **ETL DataView** is available to telecommand the test device; or you use .Net Assembly, Windows API DLL resp. ASCII protocol for a comfortable connection of your application.

### 3.3 Model and Type Designation

Automatic Test System **ATS 400**

### 3.4 Validation

This document is valid für all products of the Series 400. This series of products forms the platform for many types and operation types.

You can find the description of the test modules in the „Technical Description“.

The operation types X2, X4, X5, X6 and X8 can be selected freely and combined with every test configuration.

You can find the number of the product on the type label. The type label is affixed at the back side of the test system.

Technical changes without prior announcement are reserved.

### 3.5 Handling according to Regulations



**DANGER**

Handling according to the regulations has to be taken care of!!  
Please regard chapter 2.1 Safety Information.

### 3.6 Maintenance work

To check the safety circuit, regular maintenance work is necessary depending on the configuration used.

These are described in the chapters on the safety circuit.

For variants X4, X5, X6 and X8, backups of the configuration, test plans and result files must be performed regularly or if required.

### 3.7 Scope of Delivery

Please check the delivery for completeness. Thereby mind possibly smaller packages as well.

The following parts must be included:

- 1 power cable
- 1 instruction manual
- 1 safety circuit plug
- 1 plug for the warning lamps
- 1 Quick start manual for **ETL DataView** 3 (not for type X2)

Please check the delivery for possible transport damage.



In case of a transport damage, please inform the forwarder immediately (factual report).  
Please keep the special packaging to ensure the ideal protection when the device is forwarded (e.g. for recalibration).

### 3.8 Terms and definitions

Term	Explanation
Baseboard	Board that establishes the connection between the safety circuit board and the <b>ATS 400</b> .
FAIL SAFE	Safe state; the system enters this state when it has detected an error. In this state, the relay outputs are switched off and the inputs are ignored. This state can only be exited by a reset.
Current enabling circuit	The circuit through which the high voltage supply is switched. This circuit is switched via two positive-guided relays connected in series.
Safety circuit	This term is used for two meanings. <ul style="list-style-type: none"> <li>- Entire structure consisting of the safety circuit board, the baseboard, the current enabling circuits and the warning lamps.</li> <li>- Dual circuit wiring connected to the safety circuit plug and connected to the system.</li> </ul>
SC	Safety circuit
SC-NG	Safety circuit next generation
Safety circuit board	Board, which implements the safety functions.

## 4 About the Test System

### 4.1 Operating Components at the Front Side (all Types)

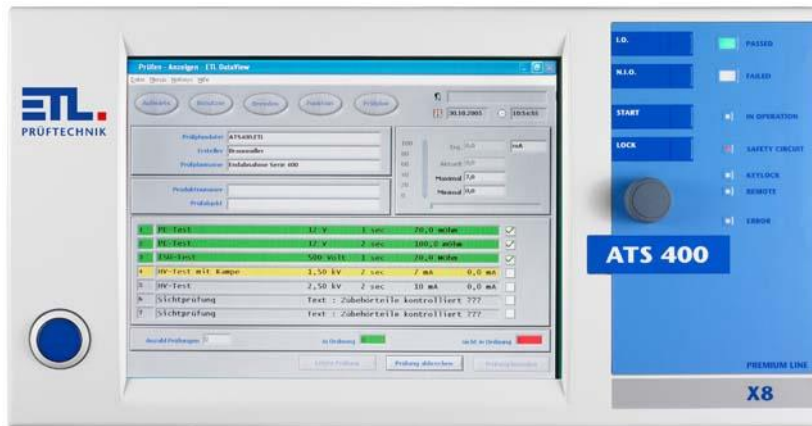



#### 4.1.1 Main Switch

<p>The main switch is used to activate the test system. Depending on the test system, the main switch is either an illuminated button or a key switch button.</p>	
---	--

#### 4.1.2 Multifunctional Rotary Switch „Navigation Plus“









<p>For the navigation in the operation menus. By pushing the rotary switch an input acknowledgment (Enter) will be released. Swivelling it to the right will move the focus rightwards or downwards. Swivelling it to the left will move the focus leftwards or upwards.</p>	
--	---

#### 4.1.3 Keyboard Foils

<p><b>Button „PASS“:</b> Input of the result „GOOD“, e.g. to confirm a visual testing.</p>	
<p><b>Button „FAIL“:</b> Input of the result „BAD“, e.g. to confirm a visual testing.</p>	
<p><b>Button „START“:</b> Button to initiate a test or a test step. The startconditions of a test can be input individually. The start via the starting button at the front of the test system is one of the freely adjustable startconditions.</p>	

<p><b>Button „LOCK“:</b>          Button to lock the safety circuit.          At a manual test with test pistols the safety circuit must be locked consciously according to EN 50191.</p>	
---	---

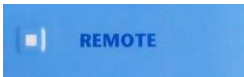
#### 4.1.4 LED Display

<p><b>LED „PASSED“:</b>          Indication of the overall result of the measurement.          “Overall result” means the result of all test steps.          Only when all test steps of a test sequence or a test plan have been O.K., the result „PASSED” is shown.</p>	
<p><b>LED „FAILED“:</b>          Indication of the overall result of the measurement. “Overall result” means the result of all test steps. When only one or several test steps of a test sequence or a test plan have not been O.K., the result „FAILED” is shown.</p>	
<p><b>LED „IN OPERATION“:</b>          Indication whether a test step is being active.          The LED goes out between the test steps until the next test step is active again.</p>	
<p><b>LED „SAFETY CIRCUIT“:</b>          Indication whether the safety circuit is open or locked.</p>	
<p><b>LED „POWER ON“:</b>          Indication whether the test system is activated or a safe state (FAIL SAFE) is reached.</p>	
<p><b>LED „KEYLOCK“:</b>          Indication whether the keyboard or the control elements are completely or partly locked. Control elements can be locked in groups or completely. The control elements might also be locked at a remote access by a superordinate control.</p>	
<p><b>LED „REMOTE“:</b>          Indication whether the test system is being controlled by a superordinate control and whether the operation via the front of the test system is therefore locked partly or completely.</p>	
<p><b>LED „ERROR“:</b>          Indication whether an error of the test system has arrived. It might be a temporary error (e.g. overheat shutdown as a consequence of an overload of the test system) or a serious, possibly unrecoverable error. Please pay attention to the notifications and error indications on the display or activate the service to read the error memory via interface. For more information see chapter Display of LED Error.</p>	

#### 4.1.5 Display

Depending on the equipment of the test system, the front is either equipped with a display or not.

The types X2 and X6 have a closed front without a display.

The Types X4, X5 and X8 are equipped with touchscreen displays.

Please regard the chapter Equipment and Control Types.

## 4.2 Equipment and Control Types

The test system can be delivered in 4 different types of equipment resp. control concepts – from the pure Remote Type through to the PC-based system with TFT-Display and touchscreen.

### 4.2.1 PREMIUM LINE X2: The Remote Type

- Remote control via PC with the software **ETL DataView**
- Remote control via PC with a customer-specific application and ETL drivers (.Net Assembly, Windows API DLL, ASCII)
- Remote control via PLC including a digital programme selection
- Several connectivity options for a control interface to input visual testings and to display status messages



### 4.2.2 PREMIUM LINE X4: The Stand-Alone Type

- Basic functions like the X2-Type and self-operation
- 640 x 480 graphic-touchscreen for the editing of test plans, for status messages and parameter changes
- Navigation Plus with rotary encoder
- Storing of test plans and results (XML, HTML, CSV)



#### 4.2.3 PREMIUM LINE X6: The PC-Inside Type

- Basic functions like the X2-Type and self-operation
- Integrated PC with the software **ETL DataView** able to do standard printing, saving as XML, PDF, HTML, CSV and direct label printing on a Zebra printer.
- External monitor via VGA-connection, location flexible
- Navigation Plus with rotary encoder
- All PC-interfaces such as Ethernet, USB, Barcode, ...
- Installation and Windows 7 Professional 32 bit Edition inclusive
- Expandable functions like e.g. remote maintenance, status report via E-Mail, ...



#### 4.2.4 PREMIUM LINE X8: The High-End Type

- Basic functions like the X2-Type and self-operation
- Premium Type with integrated PC, TFT Display (800 x 600 / ca. 236 x 174,3 mm) and touchscreen
- integrated PC with the software **ETL DataView** able to do standard printing, saving as XML, PDF, HTML, CSV and direct label printing on a Zebra printer.
- TFT-Touchscreen with extended operating functionality
- Navigation Plus with rotary encoder
- All PC-interfaces such as Ethernet, USB, Barcode, ...
- Installation and Windows 7 Professional 32 bit Edition inclusive
- Expandable functions like e.g. remote maintenance, status report via E-Mail, ...



### 4.3 Back Side with Interfaces



#### Depiction of the Types X8 and X6 with HV connection jacks.

With the variants X4 and X5 the computer interface, shown on the right side, is designed differently.

In variant X2, the PC interface, shown on the right, is missing.



#### Depiction of the Types X8 and X6 with a system plug.

With the variants X4 and X5 the computer interface, shown on the right side, is designed differently.

In variant X2, the PC interface, shown on the right, is missing.

#### Please pay regard to chapter Earthing regarding the grounding of the system.

Current systems have a newer PC board, using another layout of connectors. There are no PS2 connectors. Instead it has now 4 USB connectors.

There are the following connectors available:

- RS232 data termination equipment, in Windows as COM1.
- VGA analog, Sub-D 15 pole
- 1 Gigabit LAN port

- 4 USB connectors
- 1 Audio Line out
- 1 Audio Mic in

#### 4.3.1 ETL-Interface for Selection and Operation Panels

The ETL-Interface contains the most important digital inputs and outputs to the remote control via PLC or to the connection of an operation interface. The settings and using of the interface is described in chapter 9 starting from page 46.

The interface is executed as a 25-pole SUB-D connection jack (female). The exact specifications of the pins are described in the following table:

PIN	IN/OUT	Designation	Explanation
1	Out	Output 24 V	
2		GND	
3	Out 1	Output PASS	Digital display of the overall result, e.g. to drive a "PASS"-lamp or a PLC.
4	Out 2	Output FAIL	Digital display of the overall result, e.g. to drive a „FAIL“-lamp or a PLC.
5	Out 3	Output IN OP	Digital display for a feedback signal of an active safety-related test of the test system. Between the individual tests the bit changes from 1 to 0.
6	Out 4	Output RESULT-IMPULSE	Adjustable digital display of an impulse, e.g. an impulse for an error buzzer in case of the overall result "FAIL" or an impulse for an expulsion of the test object in case of the overall result "PASSED".
7	Out 5	Output DUMMY-OUT	Digital output for the demand for or the start of a dummy test via e.g. a PLC. The test system is now waiting for the feedback signal of the PLC or for the dummy-test object to be ready for the test.
8	Out 6	Output READY FOR OPERATION	Digital Output to signalize the operable status after the activation of the device. The device then stands in a dormant state, e.g. waiting for the starting command of a PLC.
		or Locking	Using safety cabinets this output can be used to lock the safety cabinet even during the time no test is active. This is supported with <b>ETL DataView 3</b> version 3.8.33.160 or newer and remote control using <b>ETLKWP protocol</b> .
9	Out 7	Output SHK	Safety Circuit: 0 = open, 1 = locked
		or Output external relay 1	Digital output for the selection of an external relay. The actuation and release time of the relay must not be longer than 200 ms because the corresponding test starts after that time.

10	Out 8	Output KÜ	Contact monitoring: 0=open, 1= contacts closed
		or Output external relay 2	Digital output for the selection of an external relay. The actuation and release time of the relay must not be longer than 200 ms because the corresponding test starts after that time.
11	IN 1	Button Start	Digital input to start a test operation.
12	IN 2	Button Stop	Digital input to stop a test.
13		GND	
14	Out	Output 24 V	
15	IN 3	Button PASS	Digital input to input a good test result by the test person.
16	IN 4	Button FAIL	Digital input to input a bad test result by the test person.
17	IN 5	Button DUMMY-IN	Digital input to report to the PLC that the dummy-test object is ready for the test.
18	IN 6	Input PP-SELECT (optional article 203020)	The test program can be indicated digitally, e.g. by a PLC. The PLC creates the digital combination at the Pins IN 7 – IN 12. Now the PLC has to set the Select Input (outside of the test process). As long as the input PP SELCT is set and the combination changes the corresponding test program will be loaded. The PP SELCT input must be set for at least 18 ms to recognize the combination. The program has been filed before as a parameter data set in the test system.
19	IN 7	Input PP Bit 1	Bit combination for SELECT PP
20	IN 8	Input PP Bit 2	Bit combination for SELECT PP
21	IN 9	Input PP Bit 3	Bit combination for SELECT PP
22	IN 10	Input PP Bit 4	Bit combination for SELECT PP
23	IN 11	Input PP Bit 5	Bit combination for SELECT PP
24	IN 12	Input PP Bit 6	Bit combination for SELECT PP
25		GND	

#### 4.3.2 User-Interface: Free configurable IOs (optional article 201327)

The USER-Interface contains additional digital inputs and outputs for the query of limit switches and for the setting of outputs and actuators.

The User-Interface can be programmed comfortably with an own test step card. It is supposed to replace an additional controller, e.g. a PLC, in simple controlling tasks.

The User-Interface is optional. It is executed as a 25-pole SUB-D connection jack (female) The exact specification of the pins are described in the following table:

PIN	IN/OUT	Designation	Explanation
-----	--------	-------------	-------------



1	Out	Output 24 V	
2		GND	
3	Out 1	Digital output 1	Freely configurable digital output, e.g. for the selection of cylinders or the like.
4	Out 2	Digital output 2	do.
5	Out 3	Digital output 3	do.
6	Out 4	Digital output 4	do.
7	Out 5	Digital output 5	do.
8	Out 6	Digital output 6	do.
9	Out 7	Digital output 7	do.
10	Out 8	Digital output 8	do.
11	IN 1	Digital input 1	Freely configurable digital input, e.g. for the query of limit switches or the like.
12	IN 2	Digital input 2	do.
13		GND	
14	Out	Output 24 V	
15	IN 3	Digital input 3	do.
16	IN 4	Digital input 4	do.
17	IN 5	Digital input 5	do.
18	IN 6	Digital input 6	do.
19	IN 7	Digital input 7	do.
20	IN 8	Digital input 8	do.
21	IN 9	Digital input 9	do.
22	IN 10	Digital input 10	do.
23	IN 11	Digital input 11	do.
24	IN 12	Digital input 12	do.
25		GND	

#### 4.3.3 Common specification

The ETL-Interface and the User-Interface supply 24 Volt for external devices. All 4 Pins can supply together up to 2 A using a multfuse.

All digital outputs are source outputs.  
Each output can have a current load of 70 mA.

All digital inputs are sink inputs.  
Each input needs 24 volts. The input resistance is about 2,2 kOhm.

#### 4.3.4 ADF-Interface: Analogue IOs und Frequency Inputs (optional article 202734)

The ADF-Interface contains AD-Channels to import linearised sensor signals. By further DA-Channels measurement parameters and results can be output analogue. With the frequency inputs, e.g. a rotational speed signal can be acquired and added to a test step card for rotational speed tests. The ADF-Interface is optional.

The interface is executed as a 15-pole SUB-D connection jack (female).  
The exact specification of the pins is described in the following table:

PIN	IN/OUT	Designation	Explanation
1		+ 2,5 V	
9		+ 5 V	
2		GND	
10	IN	AD1, AD-Channel 1	0 - 10 V DC, 12 bit resolution
3	IN	AD2, AD-Channel 2	0 - 10 V DC, 12 bit resolution
11	IN	AD3, AD-Channel 3	0 - 10 V DC, 12 bit resolution
4	IN	AD4, AD-Channel 4	0 - 10 V DC, 12 bit resolution
12	OUT	DA1, DA-Channel 1	0 - 10 V DC, analogue output of test statistics during the test
5	OUT	DA2, DA-Channel 2	0 - 10 V DC, analogue output of test statistics during the test
13	IN	FREQ 1.0	Frequency input for rotational speed acquisition sensor 1
6	IN	FREQ 1.1	Frequency input for rotational direction acquisition sensor 1
14	IN	FREQ 2.0	Frequency input for rotational speed acquisition sensor 2
7	IN	FREQ 2.1	Frequency input for rotational direction acquisition sensor 2
15		GND	
8	IN 3	+ 24 V DC	

#### 4.3.5 RS232-Interface

The serial interface RS232 can be used in connection with a commercially available PC, a log printer (ASCII or tape printer) or a PLC.

The interface is executed as a 9-pole SUB-D plug (male). The exact specification of the connectivity options are described in the following chapters:

##### 4.3.5.1 PC-Connection

Matching drivers (.Net Assembly, Windows API DLL) as well as the complete data management system **ETL DataView 3** are available and described in their separate instruction manuals.

A commercially available null-modem cable is used for the electric connection between a PC and the test system.

##### 4.3.5.2 Log Printer-Connection via a simple ASCII-Output

Protocol is not implemented yet!

##### 4.3.5.3 PC- or PLC-Connection via a simple ASCII-Protocol

This is an option available as article 205060.

#### 4.3.6 CAN 1: Interface for the Extension of the Test System

System extensions of the standard test system are realized via the CAN 1-Interface. So e.g. an external relay matrix can be operated by the test system with a high process reliability. There is also a processor unit with CAN in the external unit. That

way you can spare an expensive and unsafe cable system. The external task resp. hardware unit can be established modularly and autarchically. So the whole system is safer and more manageable.

The interface is build as a 9-pole SUB-D connection jack (female).

**4.3.7 CAN 2: Interface for customer-specific solution**

Functionality is not implemented yet!

**4.3.8 HV-Connections: HV-Connection Jack, double pole, HVS06C by ETL:**

<p>The contacting is realized by two potential-free high voltage outputs via suitable panel jacks HVS06C. These outputs are each executed double pole with a connection jack for plug HVP06C (A Ø 6 mm and I Ø 2 mm). In connection with the double pole high voltage test pistols HTP06C it is possible to generate a definite start signal and to guarantee a permanent cable break monitoring. In an automated surrounding ,like e.g. a test station, a contacting monitoring can be reached additionally. Thereto each test point has to be double contacted.</p>		
1	Middle braid	Sense path for contact monitoring
2	Shielding	High voltage power line

**4.3.9 Connection for a PE-Probe Tip (Protective Earth C P onductor-Test Probe):**

<p>Connection for contacting the test object via a test probe with start push button and result-LEDs.</p> <p>The start push button makes the definite start-up of the current source after the contacting possible and avoids in this way a possible damage at the surface of the test object.</p> <p>The result display in the handle piece of the test probe shows the test person the result status of the test. Therefore no direct visual of the test device is necessary.</p> <p>For a firm connection an alligator clip can be plugged in optionally.</p>	
--	---

PIN	Designation	Explanation
1	Source path	Current path at the 4-conductor measurement (parallel to PIN 6)
2	Sense path	Measuring path at the 4-conductor measurement
3	24 V DC	Internal supply voltage for the Pins 4, 5 and 7
4	Input start button	Start condition for the protective earth conductor test. By the definite start-up of the current source after the contacting of touchable metal parts the surface of the test object is protected. The corresponding start button is situated at the test probe. A signal with internal 24 V DC generates the start signal (24 V DC from PIN 3).

5	Output "FAILED" (e.g. LED red)	A result-LED in the test probe shows the test result, there is no need of a direct visual of the test device. The LED goes out during the test and shows the result after the selected test time. Output negative switching against internal 24 V DC (PIN 3)
6	Source path	Current path at the 4-conductor measurement (parallel to PIN 1)
7	Output "PASSED" (e.g. LED green)	A result-LED in the test probe shows the test result, there is no need of a direct visual of the test device. The LED goes out during the test and shows the result after the selected test time. Output negative switching against internal 24 V DC (PIN 3)

#### 4.3.10 Safety circuit and warning lamp combination

The connections and further explanations to the SHK-NG can be found in chapter 7 Safety circuit.

#### 4.3.11 Earthing

<p>Functional earthing (FE)</p> <p><b>It is important to connect the earthing at the rear side with a cable of at least 4 mm<sup>2</sup> cross section to a separate grounding point. If this is not the case it could be that during high voltage breakdown the potential may rise. This could cause damage to the logic and PC components! (Loss of guaranty)</b></p>	
---	--

#### 4.3.12 System connector 10 pole

The system connector is a connector from Harting and is installed as part number 204045.

Assignment for high voltage and insulation tests without contact monitoring

Pin	Signal
1	L1
2 + 5	PE-Source plug
3 + 4	PE-Source housing
6	L2
7	PE-Sense plug
8	PE-Sense housing
9	L1
10	L2 just connected with R-Module
Shield	Housing

Assignment for high voltage and insulation tests with contact monitoring

Pin	Signal
1	HV1/ISO1/L1 Source
2 + 5	HV2/PEX Source

Pin	Signal
3 + 4	Test Probe Source
6	HV1/ISO1/L2 Source
7	HV2/PEX Sense
8	Test Probe Sense
9	HV1/ISO1/L1 Sense
10	HV1/ISO1/L2 Sense
Shield	Housing

#### 4.3.13 System connector 12 pole

The system connector is a connector from Harting and is installed as part number 207589.

Assignment for high voltage and insulation tests without contact monitoring

Pin	Signal
a1	L1
a2 + a5	PE-Source plug
a3 + a4	PE-Source housing
a6	L2
b1	PE-Sense plug
b2	PE-Sense housing
b3	L1
b4	L2 just connected with R-Module
b5	Not connected
b6	Not connected
Shield	Housing

Assignment for high voltage and insulation tests with contact monitoring

Pin	Signal
a1	HV1/ISO1/L1 Source
a2 + a5	HV2/PEX Source
a3 + a4	Test Probe Source
a6	HV1/ISO1/L2 Source
b1	HV2/PEX Sense
b2	Test Probe Sense
b3	HV1/ISO1/L1 Sense
b4	HV1/ISO1/L2 Sense
b5	Not connected
b6	Not connected
Shield	Housing

## 5 Information for safe Operation

### 5.1 General Safety Information



**DANGER**

Depending on the type, the test system can supply high potentials with high efficiency. The safety measures demanded in VDE 0104 (En 50 191) are to observe.

- The proper status of the main cable and the test object connection cables is to observe via visual every day before starting the testing work.
- Damaged parts must be replaced or put out of operation.
- No start-up when there are obvious defects!
- Only workshops who have been authorised by ETL are allowed to open the device and overhaul it! There are no parts in the interior of the device that can be replaced by the operator.
- The **ATS 400** is a device of protection class I.
- The protective earth conductor connection of the used main cable and the power socket must be proper. Every interruption of the protective earth conductor can lead to the fact that the device might become dangerous. Therefore an interruption of the protective earth conductor is illegal.

### 5.2 Special Safety Information for High Voltage Testing and other dangerous Kinds of Testing

#### 5.2.1 Testing with High Voltage Test Pistols

##### 5.2.1.1 Fusing the Work Place

When using two high voltage test pistols, the test station must be organised according to EN 50191 (DIN VDE 0104) (Electric Test Stations), paragraph for **„Test Stations without obligatory protection against contact“**:

##### 5.2.1.2 Protecting Outsiders



**DANGER**

Outsiders must be protected from accidentally touching the test object (and so from touching the high voltage) by:

Cordoning off the test area

Warning signs WS1 and ZS 1 "High voltage, danger of life"

- Warning lamps, red-green combination
- Distances to the high voltage according to EN 50191
- Instructions

##### 5.2.1.3 Protecting the Test Person

The test person is protected by:

**DANGER**

The test person must be protected from accidentally touching the test object (and so from touching the high voltage) by:

- Using to test pistols, one in each hand.  
(It is not allowed to use only one test pistol or to carry both test pistols in one hand.)
- Potential-free high voltage (principle isolating transformer), therefore install the test object isolated against the earth potential, otherwise this protection is ineffective!
- Emergency shutdown, installed outside of the cordon
- Executing the test devices and the supplies
- Instructions

## 5.2.2 Testing with a Safety Test Cage

### 5.2.2.1 Fusing the Work Place

When a safety test cage (e.g. SICAB or DOCAB) is used, the test station is called a **„Test station with obligatory protection against contact“**. The test set-up simplifies substantially. Please regard the EN 50191 here as well.

**DANGER**

In test stations with obligatory protection against contact (test cage) a dummy resp. jumper connector must not be used because it jumps the safety circuit impermissibly! Therefore the correct setting of the safety circuit should be checked before the start of a test:

- Warning lamp green: ⇨ safety cage open
- Warning lamp red: ⇨ safety cage closed
- Install control lines and test cords so that damages and earth fault can be excluded!

## 6 First Steps, Commissioning

- Install the test system at a suitable and permissible place.
- Plug in the main cable (contained in the scope of delivery) on the back side of the device and regard the power supply: 230 V, 50 - 60 Hz. The main cable must not be longer than 3 meters and must be always detachable.
- If necessary assign the safety circuit (SHK) resp. plug in the safety circuit plug of the supplies (e.g. test cage).
- Plug the warning lamp in the plug-in connector „WK400“ on the back side of the test system.
- If necessary plug in operation components such as keyboard, barcode reader or mouse (possible depending on the equipment type).
- If necessary establish the connection to the network. Establish the connection to the Ethernet with a fitting patch plug. In case of an X6 or X8 equipment type the test system can be involved in the network (XP-Professional).
- Install the connections on the power side. Either plug in the round high voltage plugs like denoted or establish all connections with one plug-in mount if you have a test system with system connector. Secure the HV-plugs with the dedicated fittings resp. the system connector with the locking lever!
- If necessary plug in the test probe for the protective earth conductor test.
- If necessary connect operation panels or PLC controls with the ETL-Interface.
- If necessary establish the connection to a superordinate control, e.g. via the RS232-Interface for the connection of a PC application.



**DANGER**

Estimation of the test place and training of the personnel:

Have all guidelines of the standards, especially those of the EN 50191, been kept resp. implemented?

- Have you realised the necessary instructions of the test persons, e.g. electrically instructed person, necessary for electrotechnical laypersons?

- Turn on the test system.



## 7 Safety circuit

### 7.1 Basic principles

The safety circuit supports various configurations and makes an additional safety PLC or safety relay superfluous for certain applications.

Monitored warning lights are also supported.

The safety circuit can be used from IO-CPU Version 33504 and **ETL DataView 3** from Version 3.35.70.261 , the .Net Assembly from Version 5.2.0, the Windows API DLL from Version 5.2.1 (in preparation) or ASCII protocol from Version 2.1.

The safety circuit consists of the safety circuit board, which performs the safety-related functions, and the baseboard, which connects to the basic device. These two boards must not be separated under any circumstances.



#### DANGER

If a fault is detected by the safety circuit, it enters the safe state FAIL SAFE. The machine must not be operated if the cause of the safe state (FAIL SAFE) is still present or if the displayed error message repeatedly indicates an internal error.



#### Maintenance

Maintenance work must be carried out every six months. The necessary work must be carried out by a qualified electrician. Further information can be found with the respective configuration.



#### Note

1. The connectors for the warning lamp combination and the safety circuit have changed. Adapters are required to connect existing accessories (e.g. test cage or two-hand operation).
2. The warning lamp combination must always be provided with a plug, even if no warning lamps are connected, as the configuration must now always be detected.
3. The safety circuit must always be provided with a plug, even if a safety circuit is not necessary due to the type of test used (e.g. protective conductor test), since the configuration must now always be detected.
4. If the plug of the safety circuit or the warning lamp combination is removed and plugged in again, the new configuration must be determined again. To do this, press the **Reset SC** button in **ETL DataView 3** in **Service** -> **Safety circuit** or switch the device off and on.

## 7.2 Safety parameters

The safety circuit meets the following standards:

SIL3, PLe, Kat4	EN61508:2010 Parts 1-7
	DIN EN ISO 13849-1:2016-06
	DIN EN 62061:2016-05
	DIN EN 60947-1:2015-09

The following security level is achieved in the corresponding configuration:

Configuration 1	SIL3, PLe, Kat4
Configuration 2	SIL3, PLe, Kat4
Configuration 3	SIL3, PLe, Kat4
Configuration 4	SIL3, PLe, Kat4
Configuration 5	SIL2, PLd, Kat2
Configuration 6	SIL3, PLe, Kat4
Configuration 7	SIL3, PLe, Kat4
Configuration 8	SIL3, PLe, Kat4
Configuration 9	SIL3, PLe, Kat4

The following safety parameters are achieved:

PFH	$4,46 * 10^{-9}$ 1/h
B	2%
MTTR	8 h (just for calculation)
SFF	99,90 %
MTTF <sub>D</sub>	1018 a
DC <sub>avg</sub>	99 %

## 7.3 Pin numbering of the sockets

The pins are counted counterclockwise when looking at the solder side of the corresponding connector.

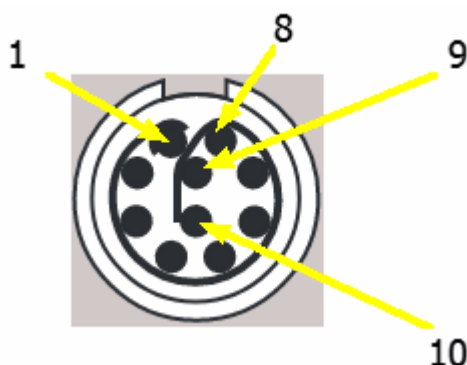

## 7.4 Socket warning lamp combination

The connection of the warning lamp combination is a 10-pole LEMO PKA.M1.0NL.LJ socket with a coding of 40° and a yellow marking.

PIN	Notation	Description
1	WL1(rt)	Output for the warning lamp 1 (red)
2	E1WL1	Input 1 for the warning lamp 1 (red)
3	E2WL2	Input 2 for the warning lamp 2 (green)
4	O4	Output for the recognition of the configuration

PIN	Notation	Description
5	E2WL1	Input 2 for the warning lamp 1 (red)
6	WL2(gn)	Output for warning lamp 2 (green)
7	E1WL2	Input 1 for the warning lamp 2 (green)
8	GND	Ground
9	O3	Output for the supply of the first monitoring element
10	O2	Output for the supply of the second monitoring element

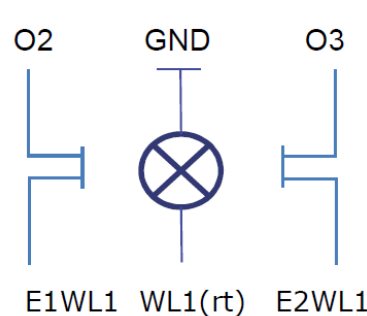
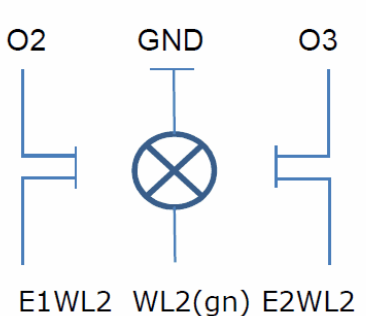
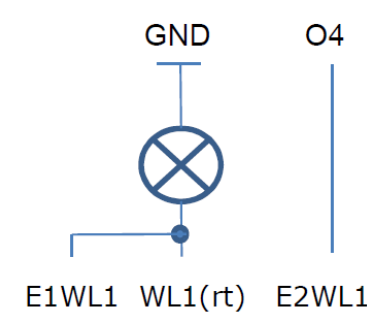
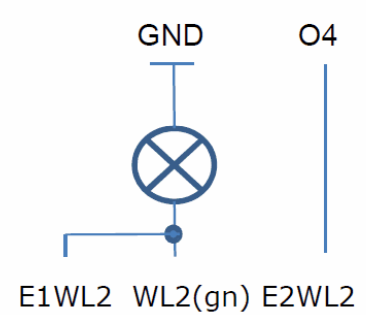
Monitoring	Warning lamp 1 (red)	Warning lamp 2 (green)
Monitored		
Not monitored		

### 7.4.1 Plug with cable

Plugs with assembled cables with open ends are available under part numbers 210967 (3 m) and 210966 (10 m). The bend protection sleeve is yellow.

Pin	Notation	Wire colour
1	WL1(rt)	White
2	E1WL1	Brown
3	E2WL2	Green
4	O4	Yellow
5	E2WL1	Gray
6	WL2(gn)	Pink
7	E1WL2	Blue
8	GND	Red
9	O3	Black
10	O2	Violet

## 7.5 Socket safety circuit

The connection of the safety circuit is a 10-pin LEMO PKG.M1.0NL.LN socket with a coding of 0 ° and a black marking.

PIN	Notation	Description
1	O1	Output 1
2	O2	Output 2
3	O3	Output 3
4	E4	Input 4
5	E5	Input 5
6	E6	Input 6
7	E7	Input 7
8	E8	Input 8
9	Vcc	Supply, 24 V, max. 0,5 A, PPTC
10	GND	Ground

The safety circuit can be used in various configurations via the wiring. The configurations cover corresponding applications on the test bench.

### 7.5.1 Plug with cable

Plugs with assembled cables with open ends are available under part numbers 210965 (3 m) and 210957 (10 m). The bend protection sleeve is black.

Pin	Notation	Wire colour
1	O1	White
2	O2	Brown
3	O3	Green
4	E4	Yellow
5	E5	Gray
6	E6	Pink
7	E7	Blue
8	E8	Red
9	Vcc	Black
10	GND	Violet

### 7.5.2 Configuration 0: No connection

Wiring diagram

**O1** ○

**O2** ○

**O3** ○

**E4** ○

**E5** ○

**E6** ○

**E7** ○

**E8** ○

This configuration is detected if no plug is inserted.

This configuration always results in a FAIL SAFE.

### 7.5.3 Configuration 1: Two hand appliance

Wiring diagram

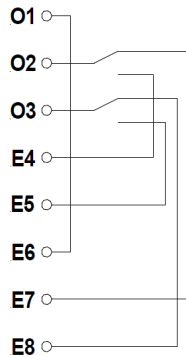

When switching on, the two-hand control must not be actuated.

There is a simultaneity monitoring with 0.5 s. If the simultaneity is violated, the enabling circuits are not closed and a correct switching sequence is maintained (ie simultaneity is maintained).



#### Initial operation

The desired configuration is displayed by **ETL DataView 3**.

If only one switch is actuated or if simultaneity is violated, the enabling circuits must not close.



#### Maintenance

The maintenance work must be carried out twice a year.

The device must be switched off. The plug for the safety circuit must be removed. The device must be switched on. The configuration 0 (no plug inserted) must be recognized.

If the connector for the configuration is plugged in, a path in the safety circuit must be opened when the release circuit is closed. The release circuits must open. If the path is closed again, the release circuits must not close.

The test must be repeated with the other safety circuit.

It must be checked for correct function.

The connected safety elements must be checked for mechanical damage and proper function and replaced if necessary.

### 7.5.4 Configuration 2: Protective door / test cage with 2 closers

Wiring diagram

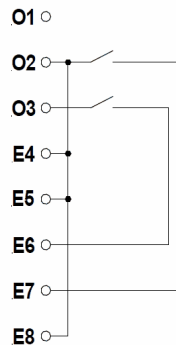

The switch position corresponds to the open door.

When switching on the protective door is open or waiting for an open protective door.

When switching on the switch positions must not be unequal.

There is a simultaneity monitoring with 2.5 s. If the simultaneity is violated, the enabling circuits are not closed and a correct switching sequence is maintained (ie simultaneity is maintained).



#### Initial operation

The desired configuration is displayed by **ETL DataView 3**.

With a closed protective door, the enabling circuits must not close when switching on.

If only one switch is actuated or if simultaneity is violated, the enabling circuits must not close.



#### Maintenance

The maintenance work must be carried out twice a year.

The device must be switched off. The plug for the safety circuit must be removed.

The device must be switched on. The configuration 0 (no plug inserted) must be recognized.

If the connector for the configuration is plugged in, a path in the safety circuit must be opened when the release circuit is closed. The release circuits must open. If the path is closed again, the release circuits must not close.

The test must be repeated with the other safety circuit.

It must be checked for correct function.

The connected safety elements must be checked for mechanical damage and proper function and replaced if necessary.

### 7.5.5 Configuration 3: Protective door / test cage with antivalent contacts

Wiring diagram

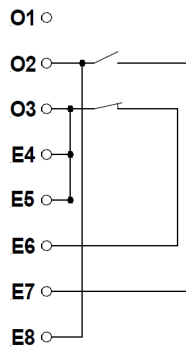

The switch position corresponds to the open door.

When switching on the protective door is open or waiting for an open protective door.

When switching on the switch positions must not be unequal.

There is a simultaneity monitoring with 2.5 s. If the simultaneity is violated, the enabling circuits are not closed and a correct switching sequence is maintained (ie simultaneity is maintained).



#### Initial operation

The desired configuration is displayed by **ETL DataView 3**.

With a closed protective door, the enabling circuits must not close when switching on.

If only one switch is actuated or if simultaneity is violated, the enabling circuits must not close.



#### Maintenance

The maintenance work must be carried out twice a year.

The device must be switched off. The plug for the safety circuit must be removed.

The device must be switched on. The configuration 0 (no plug inserted) must be recognized.

If the connector for the configuration is plugged in, a path in the safety circuit must be opened when the release circuit is closed. The release circuits must open. If the path is closed again, the release circuits must not close.

The test must be repeated with the other safety circuit.

It must be checked for correct function.

The connected safety elements must be checked for mechanical damage and proper function and replaced if necessary.

### 7.5.6 Configuration 4: Protective door automation solution

Wiring diagram

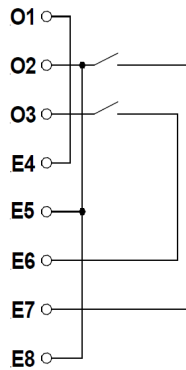

The switch position corresponds to the open door.

When switching on the two switches can be closed.

When switching on the switch positions must not be unequal.

There is a simultaneity monitoring with 2.5 s. If the simultaneity is violated, the enabling circuits are not closed and a correct switching sequence is maintained (ie simultaneity is maintained).



#### Initial operation

The desired configuration is displayed by **ETL DataView 3**.

If the safety door is closed, the enabling circuits already close at power-up.

If only one switch is actuated or if simultaneity is violated, the enabling circuits must not close.



#### Maintenance

The maintenance work must be carried out twice a year.

The device must be switched off. The plug for the safety circuit must be removed.

The device must be switched on. The configuration 0 (no plug inserted) must be recognized.

If the connector for the configuration is plugged in, a path in the safety circuit must be opened when the release circuit is closed. The release circuits must open. If the path is closed again, the release circuits must not close.

The test must be repeated with the other safety circuit.

It must be checked for correct function.

The safety circuit must be opened and closed by once the safety door is fully opened (enabling circuits open) and closed (enabling circuits closed).

The connected safety elements must be checked for mechanical damage and proper function and replaced if necessary.



### 7.5.7 Configuration 5: Check with test pistol

Wiring diagram

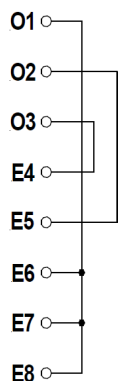

The safety circuit can be opened and closed either via the LOCK button on the front panel of the **ATS 400**, via the corresponding button in **ETL DataView 3** or via the corresponding commands from the customer application.

After opening the safety circuit, the safety circuit can only be closed after a pause of at least 0.5 s.



#### Initial operation

The desired configuration is displayed by **ETL DataView 3**.



#### Maintenance

The maintenance work must be carried out twice a year.

The device must be switched off. The plug for the safety circuit must be removed. The device must be switched on. The configuration 0 (no plug inserted) must be recognized.

If the connector for the configuration is plugged in, a path in the safety circuit must be opened when the release circuit is closed. The release circuits must open. If the path is closed again, the release circuits must not close.

The test must be repeated with the other safety circuit.

It must be checked for correct function.

The connected safety elements must be checked for mechanical damage and proper function and replaced if necessary.

### 7.5.8 Configuration 6: Smart switch

Wiring diagram

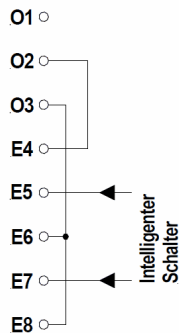

The cross-circuit monitoring E5-E7 has to be done by the intelligent switch. Blanking pulses up to 1 ms duration are filtered out (1ms filter).

The inputs E5 and E7 must always have the same level.

The intelligent switch should be powered by the 24V power supply on the configuration connector.



#### Initial operation

The desired configuration is displayed by **ETL DataView 3**.

The function of the protective door must be checked.



#### Maintenance

The maintenance work must be carried out twice a year.

The device must be switched off. The plug for the safety circuit must be removed. The device must be switched on. The configuration 0 (no plug inserted) must be recognized.

If the connector for the configuration is plugged in, a path in the safety circuit must be opened when the release circuit is closed. The release circuits must open. If the path is closed again, the release circuits must not close.

The test must be repeated with the other safety circuit.

It must be checked for correct function.

The connected safety elements must be checked for mechanical damage and proper function and replaced if necessary.

### 7.5.9 Configuration 7: Protective door with guard locking and 2 NO contacts

Wiring diagram

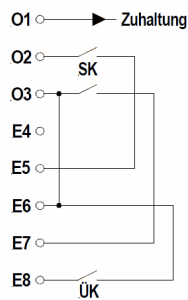

The switch position corresponds to the open door.

When switching on the protective door is open or waiting for an open protective door.

The release of the guard locking takes place via the output O1. Output O1 can drive max. 20mA!

Guard locking devices are supported which keep closed when not energised and open when energised.



#### Initial operation

The desired configuration is displayed by **ETL DataView 3**.  
The function of the protective door must be checked.



#### Maintenance

The maintenance work must be carried out twice a year.  
The device must be switched off. The plug for the safety circuit must be removed. The device must be switched on. The configuration 0 (no plug inserted) must be recognized.  
If the connector for the configuration is plugged in, a path in the safety circuit must be opened when the release circuit is closed. The release circuits must open. If the path is closed again, the release circuits must not close.  
The test must be repeated with the other safety circuit.  
When the configuration plug is unplugged, there must be no short circuit between pins E7 and E8 (measurement via multimeter).  
It must be checked for correct function.  
The connected safety elements must be checked for mechanical damage and proper function and replaced if necessary.

### 7.5.10 Configuration 8: Protective door with guard locking, potential-free antivalent contacts

Wiring diagram

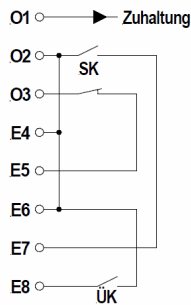

The switch position corresponds to the open door.

When switching on the protective door is open or waiting for an open protective door.

The release of the guard locking takes place via the output O1. Output O1 can drive max. 20mA!

Guard locking devices are supported which keep closed when not energised and open when energised.



#### Initial operation

The desired configuration is displayed by **ETL DataView 3**.  
The function of the protective door must be checked.



#### Maintenance

The maintenance work must be carried out twice a year.  
The device must be switched off. The plug for the safety circuit must be removed. The device must be switched on. The configuration 0 (no plug inserted) must be recognized.  
If the connector for the configuration is plugged in, a path in the safety circuit must be opened when the release circuit is closed. The release circuits must open. If the path is closed again, the release circuits must not close.  
The test must be repeated with the other safety circuit.  
When the configuration plug is unplugged, there must be no short circuit between pins E7 and E8 (measurement via multimeter).  
It must be checked for correct function.  
The connected safety elements must be checked for mechanical damage and proper function and replaced if necessary.

### 7.5.11 Configuration 9: Protective door with OSSDs

Wiring diagram

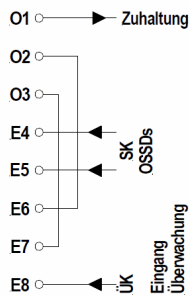

The cross-circuit monitoring E5-E7 has to be done by the intelligent switch. Blanking pulses up to 1 ms duration are filtered out (1ms filter).

The inputs E5 and E7 must always have the same level.

The intelligent switch should be powered by the 24V power supply on the configuration connector.

The plausibility of the signals SK and ÜK to each other is monitored, so that a cross-circuit E5-E8 and / or E4-E8 is detected as an error.

The release of the guard locking takes place via the output O1. Output O1 can drive max. 20mA!

Guard locking devices are supported which keep closed when not energised and open when energised.



#### Initial operation

The desired configuration is displayed by **ETL DataView 3**.  
The function of the protective door must be checked.



#### Maintenance

The maintenance work must be carried out twice a year.  
The device must be switched off. The plug for the safety circuit must be removed. The device must be switched on. The configuration 0 (no plug inserted) must be recognized.  
If the connector for the configuration is plugged in, a path in the safety circuit must be opened when the release circuit is closed. The release circuits must open. If the path is closed again, the release circuits must not close.  
The test must be repeated with the other safety circuit.  
When the configuration plug is unplugged, there must be no short circuit between pins E7 and E8 (measurement via multimeter).  
It must be checked for correct function.  
The connected safety elements must be checked for mechanical damage and proper function and replaced if necessary.

## 7.6 LED SAFETY CIRCUIT

This LED on the front indicates that the enabling circuits are open or closed. This LED flashes when the safety circuit is in the safe state (FAIL SAFE).

## 7.7 Message in ETL DataView 3

If the safety circuit goes into the safe state (FAIL SAFE), this is indicated in the status bar.

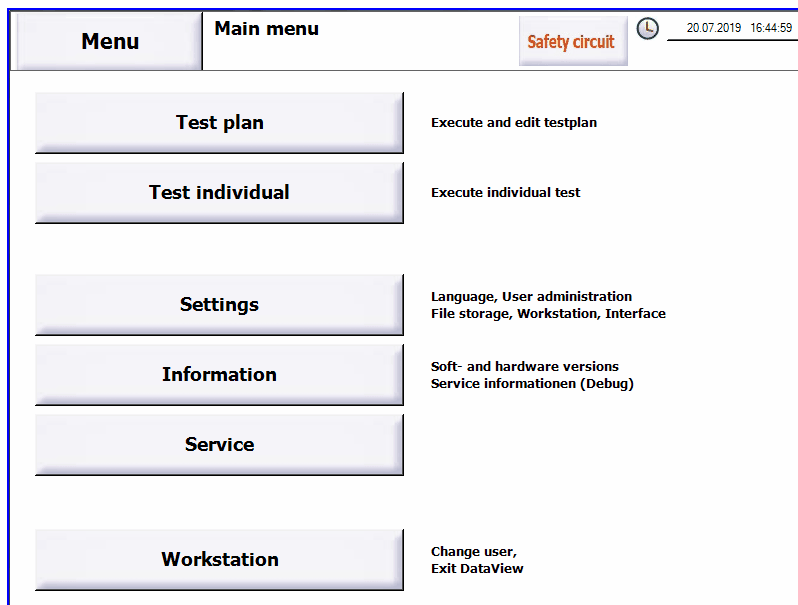

Via the displayed [Safety circuit](#) button you can directly access the status display for the safety circuit.

## 7.8 State in ETL DataView 3

To do this, the corresponding dialog must be displayed from the main menu via [Services](#) -> [Safety circuit](#).

This dialog consists of several tabs containing different displays.

**7.8.1** Tab page **Status SHK**

<b>Menu</b>	<b>Service</b> Safety circuit		20.07.2019 16:47:44
<b>State Sc</b>   <b>Detail 1</b>   <b>Detail 2</b>   <b>Detail 3</b>   <b>Debug</b>			
State machine	0x40	64	
Configuration	5		
<input type="checkbox"/> FAIL SAFE		<input type="checkbox"/> Sc manually operated (open/closed)	
Error info text			
No error  ?: Click this button for more error details. Reset Sc: New initialisation of safety circuit. Menu: Back to the main menu. Back: Back to the main menu.			
<input type="button" value="Reset Sc"/>		<input type="button" value="?"/>	
			<input type="button" value="Back"/>

Element	Description
Sate machine	Number of the state of the firmware on the safety circuit board in hexedazimal and decimal representation.
Configuration	Detected configuration on safety circuit plug.
FAIL SAFE	Indicates if there is a FAIL SAFE.
Sc manually operated (open/close)	In configuration 5 you can open and close the safety circuit manually. This checkbox is not displayed in other configurations.
Errorinfo text	Brief description of the error and explanation of the buttons.
Reset SC	The button will reset the safety circuit board and redetect the configuration.
?	The button opens a display window with an extended text about the error.

### 7.8.2 Tab page Detail 1

Menu		Service		20.07.2019 16:49:46	
Safety circuit					
State Sc		Detail 1		Detail 2 Detail 3 Debug	
State machine	0x40	64	?	<b>Error</b>	
Configuration	5		<input type="checkbox"/> Boot timeout <input type="checkbox"/> SC data timeout <input type="checkbox"/> CAN data timeout <input type="checkbox"/> FAIL SAFE <input type="checkbox"/> Boot Error		
<input type="checkbox"/> Safety relais 1 <input type="checkbox"/> Safety relais 2 <input type="checkbox"/> Safety relais slave 1 <input type="checkbox"/> Safety relais slave 2					
State	Normal				
<b>Back</b>					

Element	Description
State machine	Number of the state of the firmware on the safety circuit board in hexedazimal and decimal representation.
?	The button opens a display window with an extended text about the error.
Configuration	Detected configuration on safety circuit plug.
Safety relais 1	Indicates whether the first safety relay in the enable circuit is switched on.
Safety relais 2	Indicates if the second safety relay is on in the enable circuit.
Safety relais slave 1	Indicates whether the first safety relay on the add-on board in the enable circuit is turned on.
Safety relais slave 2	Indicates whether the second safety relay on the add-on board in the enable circuit is turned on.
State	Text of the state of the firmware on the baseboard.
Boot timeout	Indicates whether no data will be received after powering up the safety circuit board after a predetermined time.
SC data timeout	Indicates whether data is no longer received from the safety circuit board during operation.
CAN data timeout	Indicates whether no data is received via the CAN bus.
FAIL SAFE	Indicates whether the safety circuit board is in the FAIL SAFE state.
Boot error	The safety circuit board can not be brought to a normal state even after a repeated reset.



**7.8.3** Tab page **Detail 2**

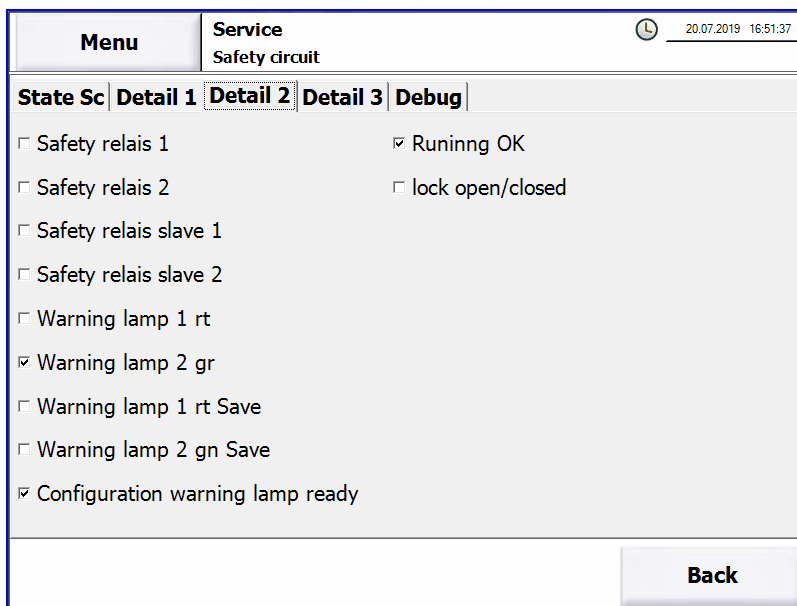

Element	Description
Safety relais 1	Indicates whether the first safety relay in the enable circuit is switched on.
Safety relais 2	Indicates if the second safety relay is on in the enable circuit.
Safety relais slave 1	Indicates if the second safety relay is on in the enable circuit.
Safety relais slave 2	Indicates if the second safety relay is on in the enable circuit.
Warning lamp 1 rt	Indicates that the warning lamp 1 (red) has been turned on.
Warning lamp 2 gr	Indicates that the warning lamp 2 (green) has been turned on.
Warning lamp 1 rt Save	Indicates that the warning light 1 (red) has been turned on and is being monitored.
Warning lamp 2 gr Save	Indicates that the warning lamp 2 (green) has been turned on and is being monitored.
Configuration warning lamp ready	Indicates that the configuration of the warning lights is complete.
Running OK	The procedure for opening and closing the safety circuit is OK.
Lock open/closed	Specifies whether the guard locking is energized.

7.8.4 Tab page **Detail 3**

<b>Menu</b>	<b>Service</b> Safety circuit	🕒 20.07.2019 16:54:36
<div style="display: flex; justify-content: space-between; border-bottom: 1px solid black;"> <span>State Sc</span> <span>Detail 1</span> <span>Detail 2</span> <span style="border: 1px solid black;">Detail 3</span> <span>Debug</span> </div>		
<b>Data from SC</b> Version <input type="text" value="1"/> <input type="text" value="5"/> <input type="checkbox"/> Slave present		<b>Data to SC</b> <input type="checkbox"/> Sc manually operated (open/closed) <input type="checkbox"/> Open Lock <input type="checkbox"/> Warning lamp flashing  <b>Version Baseboard</b> Version BB400 <input type="text" value="13006"/> HW ID <input type="text" value="1"/>
		<b>Back</b>

Element	Description
Version	Version number of the firmware of the safety circuit board.
Slave present	The additional board for a second current enabling circuit is present.
SC manually operated (open/close)	Indicates whether the current enabling circuits have been manually closed.
Open lock	Indicates that the guard locking is to be energized.
Warning lamp flashing	Indicates that the warning lamp 1 (red) should flash.
Version BB400	Version number of firmware on the base board.
HW ID	Version number of the hardware of the baseboard.

### 7.8.5 Tab page Debug

<b>Menu</b>	<b>Service</b> Safety circuit	 20.07.2019 16:56:07
State Sc   Detail 1   Detail 2   Detail 3   <b>Debug</b>		
<b>Condition</b>		<b>Data to SCBB400</b>
<input type="checkbox"/> Boot timeout		<input type="checkbox"/> SC locked
<input checked="" type="checkbox"/> Restart SC		<input checked="" type="checkbox"/> Send debug data
<input checked="" type="checkbox"/> Data from SC		<input type="checkbox"/> Lock is open
<input type="checkbox"/> SC Data timeout		<input type="checkbox"/> Reset relais on
<input type="checkbox"/> CAN data timeout		<input type="checkbox"/> Warning lamp flashing
<input type="checkbox"/> Two hand error		
<input type="checkbox"/> Start reset		
<input checked="" type="checkbox"/> Reset SC		
<input type="checkbox"/> Boot exceeded		
<input type="button" value="Back"/>		

Element	Description
Boot timeout	After switching on the safety circuit board, no data will be received after a specified time.
Restart SC	The command to reset the safety circuit module was received.
Datafrom SC	Data is received from the safety circuit module.
SC data timeout	Data is no longer received from the safety circuit module.
CAN data timeout	No more data is received over the CAN bus.
Two hand error	In configuration 1, an error caused by the tester occurred.
Start reset	After receiving the reset command, a reset was started.
Reset SC	The safety circuit module was switched off and on again.
Boot exceeded	The safety circuit module can not be brought to a normal state even after a repeated reset.
SC locked	The safety circuit should be closed.
Send debug data	Debug data should be sent.
Lock is open	It will open the guarding lock.
Reset relais on	A reset of the safety circuit board should be carried out.
Warning lamp flashing	The warning light 1 (rt) should flash.

### 7.9 Accessories

There are various accessories available so that an existing system, which is designed for the old SC, can be connected to the SC-NG.

**7.9.1 Accessories for configuration 1**

This accessory is required when using a test cage or two-hand appliance. The article number is 210651.

**7.9.2 Accessories for configuration 4**

This accessory is required if a protective door is used in an automation solution. The article number is 210652

**7.9.3 Accessories for configuration 5**

This plug is supplied as an accessory from the factory, see also chapter Scope of Delivery.

**7.9.4 Accessories for warning lamp combination**

This accessory is required to connect a warning lamp combination. The part number is 210961.

## 8 Operation

For operating the **ATS 400** you have the following possibilities:

- Operating using **ETL DataView 3**. In the types X4, X5, X6 and X8 **ETL DataView 3** is installed on the integrated computer and starts automatically when powering on the device. With the type X2 **ETL DataView 3** is optional accompanied on a medium. Using **ETL DataView 3** is described in a separate document. You can download all current documents from [Manuals for ATS 400 in English](#).
- Operating using your own application on Windows XP, Windows Vista, Windows 7, Windows 8, Windows 8.1 resp. Windows 10. For controlling the device is a .Net Assembly DLL available. The documentation of the .Net Assembly DLL is in a separate document. In this case **ETL DataView 3** can not be used and must be removed from the auto start. You can download all current documents from [Manual for .Net assembly](#).
- Operation via a self-created LabVIEW application for Windows XP, Windows Vista, Windows 7, Windows 8, Windows 8.1, Windows 10. The .Net Assembly is used to control the device. The connection VIs can be created by LabVIEW itself.
- Operating using your own application on Windows XP, Windows Vista, Windows 7, Windows 8, Windows 8.1 resp. Windows 10. For controlling the device is a Windows API DLL available. The documentation of the Windows API DLL is in a separate document. In this case **ETL DataView 3** can not be used and must be removed from the auto start. You can download all current documents from [Manual for Windows API DLL](#).
- Operating using the serial interface and the ASCII-protocoll. The documentantion of the ASCII-protocoll is in a separate document. In this case **ETL DataView 3** can not be used and must be removed from the auto start. You can download all current documents from [ASCII protocol description and examples](#).



### Licensing

Please note the licensing for the use of the **ATS 400**. With the variants X4, X5, X6 and X8 is one license included for using with **ETL DataView 3**.

This license also authorizes installation on office workstations for the administration of test plans.

For the variant X2 and for remote control you must purchase a license for each test station. In this case, please contact our sales department per e-mail on [sales@etl-prueftechnik.de](mailto:sales@etl-prueftechnik.de).

## 9 Display of LED Error

The display of the LED Error depends on the firmware version of the device.

Devices up to firmware version 33407 of the IO-CPU are flashing in the case when an overtemperature is detected. Other faults will not be signaled.

Device with firmware version 33408 or newer of the IO-CPU have different blink codes displaying different faults. Are there multiple faults only one fault will be shown.

### 9.1 Sequence of the blink code

The blink code consists of 6 bits and a synchronization. A bit will be shown by a *short signal* or a *long signal*. Between the bits is a *pause*. After the 6 bits have been transmitted the synchronization is shown with a *End signal* and a *End pause*. After the synchronization the blink code will be repeated. It will always complete blink codes transmitted.

The blink code has 5 different signals:

Short on: *short signal*, Duration duration 50 ms, indicates a logical 0

Medium on: *long signal*, Duration about 500 ms, indicates a logical 1

Long on: *end signal*, duration about 2000 ms, End of the code

Short off: *pause*, duration about 1000 ms, after a bit

Long off: *end pause*, duration about 2000 ms, End of the code

### 9.2 Meaning of the blink codes

In the following illustrations, the diagrams correspond qualitatively to the sequence of the blink code.

#### 9.2.1 Loss of communication with the LT-CPU

Error number: 1

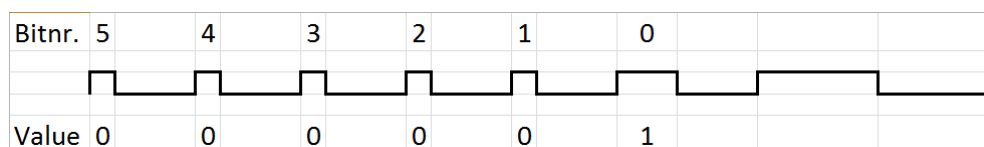

If this code remains after power off and on of the device a board is defect and the device must be sent in for repair.

#### 9.2.2 Failure of the power converter

Error number: 2

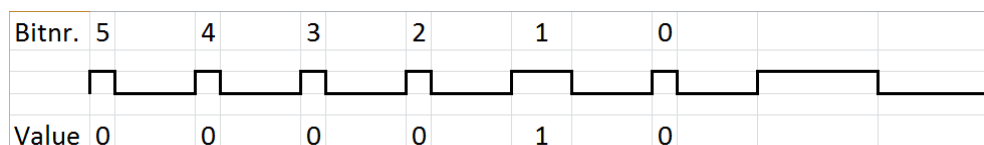

Is intermittent in the case of an overload. If the overload disappears the failure will go away within 10 s.

If this code remains after power off and on of the device a board is defect and the device must be sent in for repair.

### 9.2.3 Overtemperature

Error number: 3

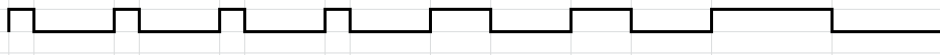
Bitnr.	5	4	3	2	1	0			
									
Value	0	0	0	0	1	1			

Exceeds the temperature in the device 70° C this situation will be triggered. If the temperature drops below 55° C again, the error disappears.

Ensure a sufficiently low ambient temperature.

### 9.2.4 Loss of communication with the HMP

Error number: 4

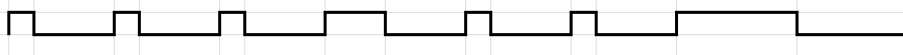
Bitnr.	5	4	3	2	1	0			
									
Value	0	0	0	1	0	0			

If this code remains after power off and on of the device a board is defect and the device must be sent in for repair.

### 9.2.5 Loss of communication with the MEP function

Error number: 5

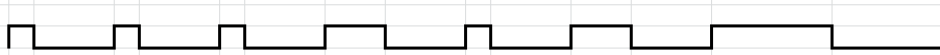
Bitnr.	5	4	3	2	1	0			
									
Value	0	0	0	1	0	1			

If this code remains after power off and on of the device a board is defect and the device must be sent in for repair.

### 9.2.6 Loss of communication with the MEP insulation test

Error number: 6

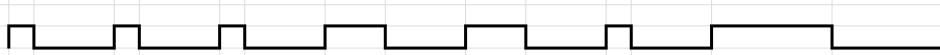
Bitnr.	5	4	3	2	1	0			
									
Value	0	0	0	1	1	0			

If this code remains after power off and on of the device a board is defect and the device must be sent in for repair.

### 9.2.7 Loss of communication with the MEP protective earth test

Error number: 7

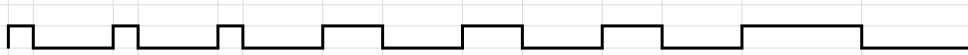
Bitnr.	5	4	3	2	1	0			
									
Value	0	0	0	1	1	1			

If this code remains after power off and on of the device a board is defect and the device must be sent in for repair.

### 9.2.8 Loss of communication with the safety circuit

Error number: 8

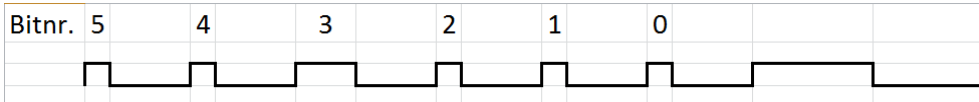
Bitnr.	5	4	3	2	1	0			
									
Value	0	0	1	0	0	0			

If this code remains after power off and on of the device a board is defect and the device must be sent in for repair.

### 9.2.9 Loss of communication with the front

Error number: 9

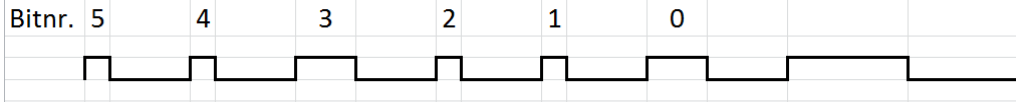
Bitnr.	5	4	3	2	1	0			
									
Value	0	0	1	0	0	1			

In the case this error is displayed the communication with the front is disturbed.

In the case the front is complete defect the blink code cannot be displayed. The other LEDs are all off or in an unusual state.

If this code remains after power off and on of the device a board is defect and the device must be sent in for repair.

### 9.2.10 Loss of communication with the 2. Userinterface

Error number: 10

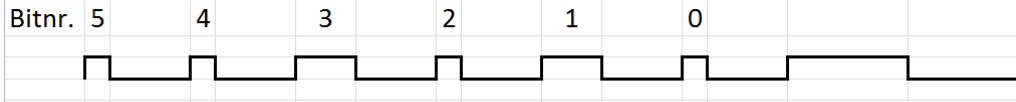
Bitnr.	5	4	3	2	1	0			
									
Value	0	0	1	0	1	0			

Supply of the 2. user-interface is fallen out.  
CAN-cable between the **ATS 400** and the 2. User-Interface is interrupted.  
The 2. User-Interface is defect and must be replaced.

### 9.2.11 Loss of communication with the ATM 400

Error number: 11

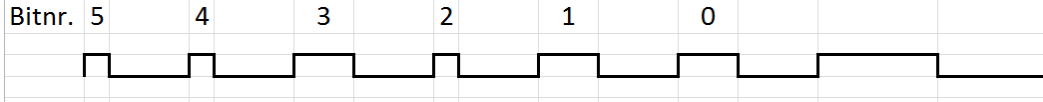
Bitnr.	5	4	3	2	1	0			
									
Value	0	0	1	0	1	1			

Supply of the ATM-module is fallen out.  
CAN-cable between the **ATS 400** and the ATM-module is interrupted.  
The ATM-module is defect and must be replaced.



### 9.2.12 Loss of communication with an external electronic source

Error number: 12

Bitnr.	5	4	3	2	1	0			
									
Value	0	0	1	1	0	0			

Supply of the external electronic source is fallen out.  
RS232-cable between the **ATS 400** and the external electronic source is interrupted.  
The external electronic source is defect and must be replaced.

### 9.2.13 Loss of communication with the adjustable transformer

Error number: 13

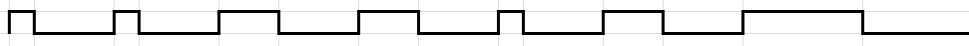
Bitnr.	5	4	3	2	1	0			
									
Value	0	0	1	1	0	1			

Supply of the adjustable transformer is fallen out.  
CAN-cable between the **ATS 400** and the adjustable transformer is interrupted.  
The adjustable transformer is defect and must be replaced.

### 9.2.14 Loss of communication with the external source

Error number: 14

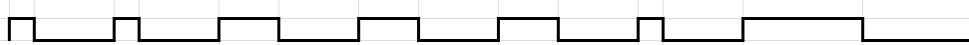
Bitnr.	5	4	3	2	1	0			
									
Value	0	0	1	1	1	0			

Supply of the external source is fallen out.  
RS232-cable between the **ATS 400** and the external source is interrupted.  
The external source is defect and must be replaced.

### 9.2.15 Loss of communication with a matrix module

Error number: 15

Bitnr.	5	4	3	2	1	0			
									
Value	0	0	1	1	1	1			

Supply of one of the matrix modules is fallen out.  
CAN-cable between the **ATS 400** and the matrix modules or between matrix modules is interrupted.  
One of the matrix modules is defect and must be replaced.

## 10 Settings of the ETL Interface

The settings can be on factory or using **ETL DataView 3**. In **ETL DataView 3** you find the dialog from the main menu under **Settings -> I/O-Interface**. Grayed out elements are for information only and are related to the equipment of the device. The settings for an external control and the tones can be configured independently for the pass and failed case.

Closing the dialog with the button **Back** will save the settings. Closing the dialog with the button **Menu** the settings will not be saved. The settings are stored in the **ATS 400**.

The time diagrams for the different settings are valid using **ETL DataView 3**. When using a self-created application and controlling it via the .Net Assembly or Windows API DLL or via the ASCII protocol, all commanding is done via the interface.

In the case a test plan consists of several test steps the signals **In Operation** and **Ready for Operation** will change there state for each test step.

It is only the start signal as start condition displayed. This must be used in the test plan as start condition. Other signals can be used by **ETL DataView 3**. For the following diagrams these signals are considered as set. Using the setting **Safety circuit** then security curcuit must be used as start condition instead of start signal.

### 10.1 Standard setting

This setting is factory default. There will be not output on the ETL interface and no tones.

Menu	Settings	20.07.2019 16:32:37
	I/O Interface	
	<b>Out Pass (I. O.)</b> Disabled Timer: 0,00 s <input type="checkbox"/> Beep I. O. Beep Time 2,00 s <input checked="" type="checkbox"/> Disable SC, Con <input type="checkbox"/> Keep Polarity <input type="checkbox"/> Hold matrix at start with contacting <input type="checkbox"/> Warn lamp flashing <input type="checkbox"/> Adaptive HV timing	<b>Out Fail (N. I. O.)</b> Disabled Timer: 0,00 s <input type="checkbox"/> Beep N. I. O. Beep Time 5,00 s <input type="checkbox"/> Disable HVAC <input type="checkbox"/> Enable HVDC8 <input type="checkbox"/> Enable R Module <input type="checkbox"/> Enable PE with Con <input type="checkbox"/> Disable analog output
	<b>Back</b>	

## 10.2 Enabled

Using this setting the output will be active until the next device under test will be tested. With this setting each test step can be started with the start signal.

Menu	Settings	20.07.2019 16:35:23
	I/O Interface	
<b>Out Pass (I. O.)</b>		
Enabled		
Timer:	0,00 s	
<input type="checkbox"/> Beep I. O.		
Beep Time	2,00 s	
<input checked="" type="checkbox"/> Disable SC, Con		
<input type="checkbox"/> Keep Polarity		
<input type="checkbox"/> Hold matrix at start with contacting		
<input type="checkbox"/> Warn lamp flashing		
<input type="checkbox"/> Adaptive HV timing		
<b>Out Fail (N. I. O.)</b>		
Enabled		
Timer:	0,00 s	
<input type="checkbox"/> Beep N. I. O.		
Beep Time	5,00 s	
<input type="checkbox"/> Disable HVAC		
<input type="checkbox"/> Enable HVDC8		
<input type="checkbox"/> Enable R Module		
<input type="checkbox"/> Enable PE with Con		
<input type="checkbox"/> Disable analog output		
<b>Back</b>		

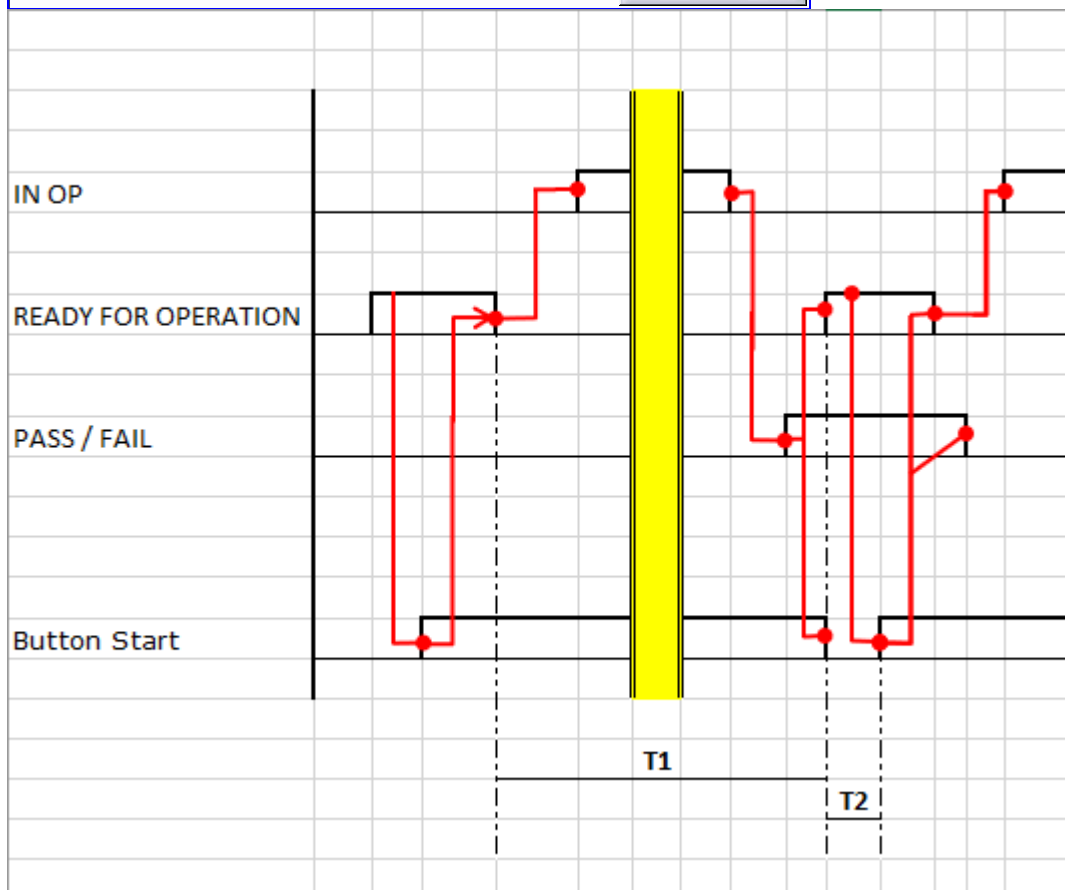

Symbol	Name	Limits	Annotation
T <sub>1</sub>	Testtime	> 200 ms	Time from start of one test until the start of the next test.
T <sub>2</sub>	Response time	> 18 ms	Necessary minimum time to recognize a change in the start signal.

### 10.3 Button Start

Using this setting the output will be active as long as the start signal is active. Using this setting only the whole test plan can be started with the start signal.

Menu	Settings	20.07.2019 16:37:21
	I/O Interface	
<b>Out Pass (I. O.)</b>	<b>Out Fail (N. I. O.)</b>	
Button Start	Button Start	
Timer: 0,00 s	Timer: 0,00 s	
<input type="checkbox"/> Beep I. O.	<input type="checkbox"/> Beep N. I. O.	
Beep Time 2,00 s	Beep Time 5,00 s	
<input checked="" type="checkbox"/> Disable SC, Con	<input type="checkbox"/> Disable HVAC	
<input type="checkbox"/> Keep Polarity	<input type="checkbox"/> Enable HVDC8	
<input type="checkbox"/> Hold matrix at start with contacting	<input type="checkbox"/> Enable R Module	
<input type="checkbox"/> Warn lamp flashing	<input type="checkbox"/> Enable PE with Con	
<input type="checkbox"/> Adaptive HV timing	<input type="checkbox"/> Disable analog output	
<b>Back</b>		

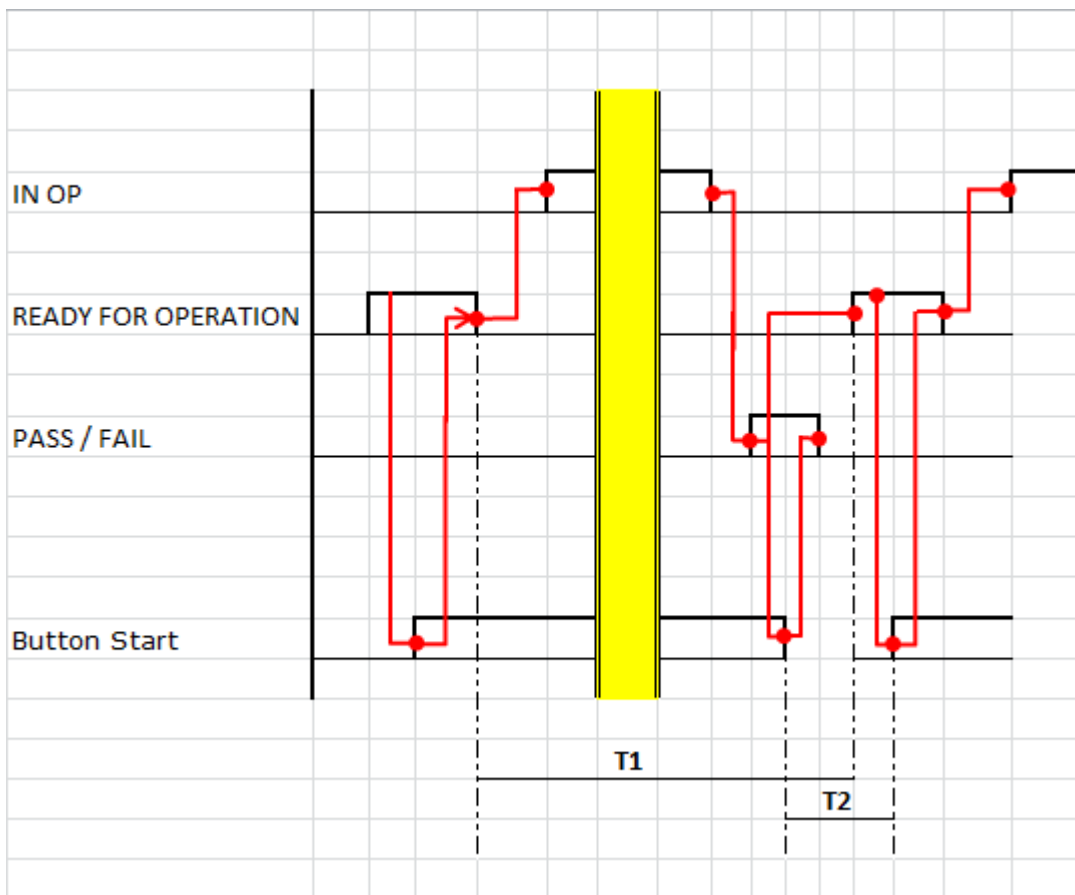

Symbol	Name	Limits	Annotation
T <sub>1</sub>	Testtime	> 200 ms	Time from start of one test until the start of the next test.

Symbol	Name	Limits	Annotation
T <sub>2</sub>	Response time	> 18 ms	Necessary minimum time to recognize a change in the start signal.

## 10.4 Time

Using this setting the output will be active according to the time given in **Timer:**. The time can be set in steps of 10 ms. As maximum time 10 seconds is possible.

**Menu**

**Settings**  
 I/O Interface

20.07.2019 16:38:58

**Out Pass (I. O.)**

Time Time

Timer: 0,00 s

Beep I. O.

Beep Time 2,00 s

Disable SC, Con

Keep Polarity

Hold matrix at start with contacting

Warn lamp flashing

Adaptive HV timing

**Out Fail (N. I. O.)**

Time Time

Timer: 0,00 s

Beep N. I. O.

Beep Time 5,00 s

Disable HVAC

Enable HVDC8

Enable R Module

Enable PE with Con

Disable analog output

**Back**

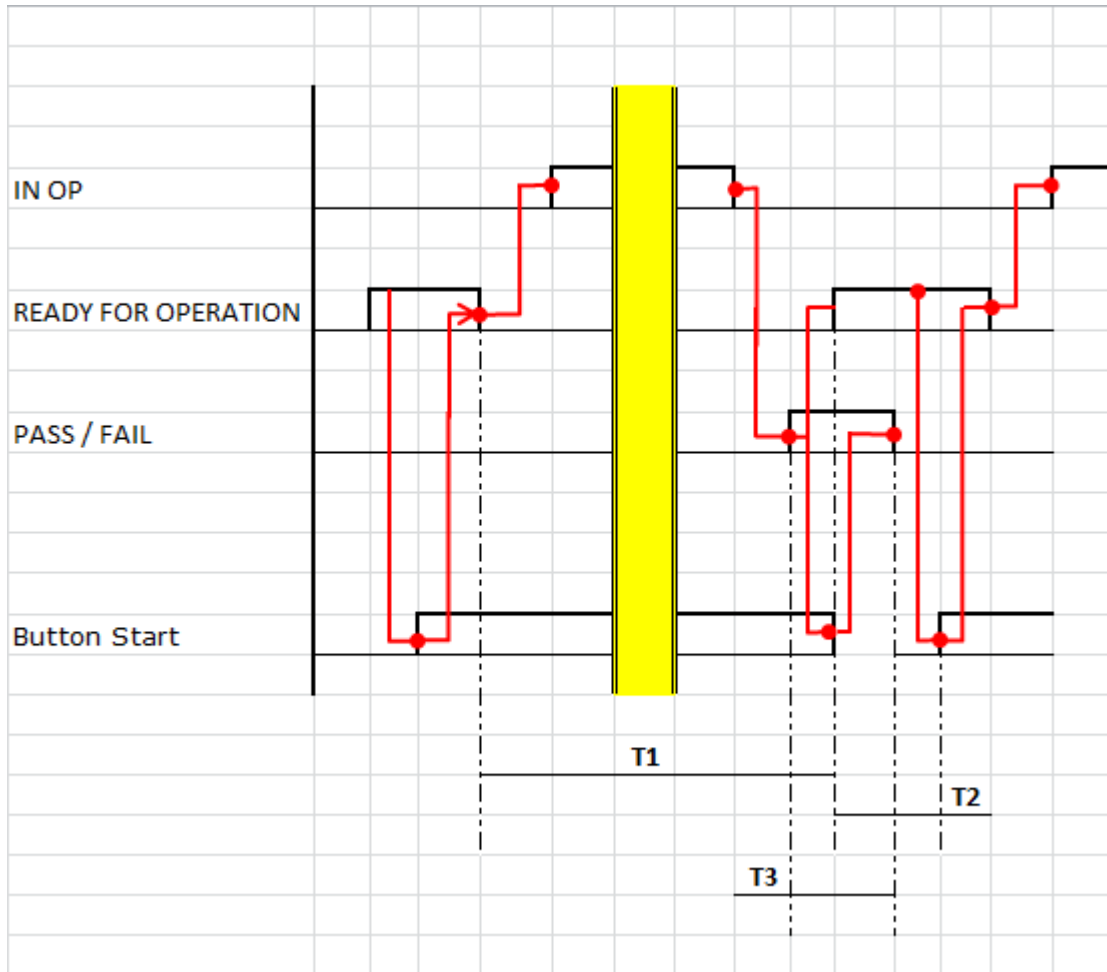

Symbol	Name	Limits	Annotation
T <sub>1</sub>	Testtime	> 200 ms	Time from start of one test until the start of the next test.
T <sub>2</sub>	Response time	> 18 ms	Necessary minimum time to recognize a change in the start signal.
T <sub>3</sub>	Result time	10 ms – 10 s	Time the result will be available. Calculate the time according to the formula: $T_3 = T_{\text{Zyklus}} + 18 \text{ ms}$ , where $T_{\text{Zyklus}}$ is the cycle time of the polling. Round up the value to the next multiple of 10 ms.

## 10.5 Safety circuit

Using this setting the output will be active as long as the safety circuit is active.  
Using this setting only the whole test plan can be started with the safety circuit.

Menu	Settings	20.07.2019 16:40:16
	I/O Interface	
<b>Out Pass (I. O.)</b>		
Security Circuit		
Timer:	0,00 s	
<input type="checkbox"/> Beep I. O.		
Beep Time	2,00 s	
<input checked="" type="checkbox"/> Disable SC, Con		
<input type="checkbox"/> Keep Polarity		
<input type="checkbox"/> Hold matrix at start with contacting		
<input type="checkbox"/> Warn lamp flashing		
<input type="checkbox"/> Adaptive HV timing		
<b>Out Fail (N. I. O.)</b>		
Security Circuit		
Timer:	0,00 s	
<input type="checkbox"/> Beep N. I. O.		
Beep Time	5,00 s	
<input type="checkbox"/> Disable HVAC		
<input type="checkbox"/> Enable HVDC8		
<input type="checkbox"/> Enable R Module		
<input type="checkbox"/> Enable PE with Con		
<input type="checkbox"/> Disable analog output		
<b>Back</b>		

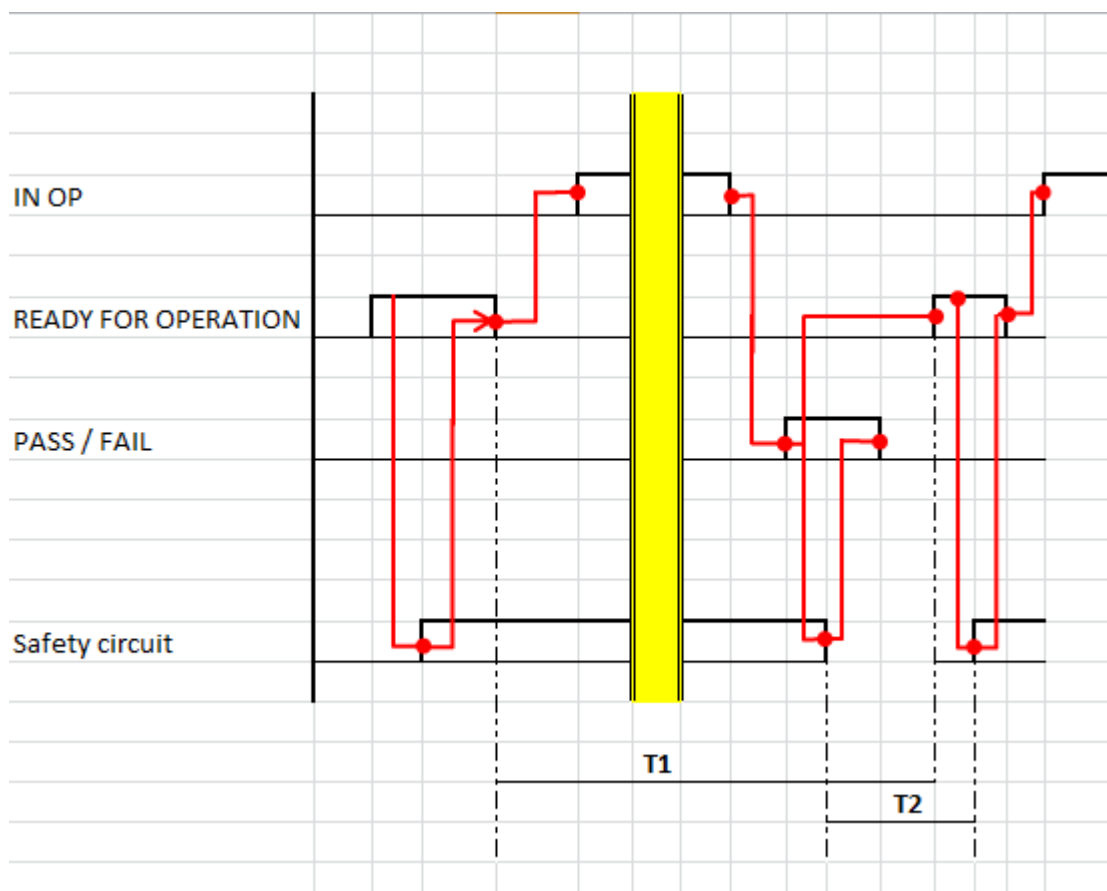

Symbol	Name	Limits	Annotation
T <sub>1</sub>	Testtime	> 200 ms	Time from start of one test until the start of the next test.
T <sub>2</sub>	Response time	> 18 ms	Necessary minimum time to recognize a change in the start signal.

## 10.6 Using the Buzzer

The built in buzzer will be used if the checkbox **Beep I.O.** resp. **Beep N.I.O.** is active. The duration of the tone depends on the time given in the field **BeepTime**.

The buzzer will also be activated when powering on the system if the checkbox for **Beep I.O.** is active.

## 10.7 Disable SC, Con

In the case this checkbox is inactive the signals **Security circuit closed** and **Contacting closed** are routed to the ETL Interface.

Is this checkbox active this signals can be used to control an external equipment. In **ETL DataView 3** this will be configured in the test steps on the property page **Matrix**, using your own application this controlled by the parameter **Contacting**.

## 10.8 KeepPolarity

Is this checkbox inactive an optional relais matrix will be switched to the default position at the end of a test plan.

Is this checkbox active the position of an optional relais matrix will be kept active after the end of a test plan.

## 10.9 Hold matrix at start with contacting

Uses a test step a matrix the matrix will be turned off after 2 minutes when the step will not be started.

In this situation you cannot start with contact monitoring.

Setting this check box and contact monitoring is a start condition the matrix will not be turned off after 2 minutes.

## 10.10 Warn lamp flashing

Has the device IO-CPU firmware 33244 or newer and safety circuit firmware 2 or newer this checkbox will be displayed.

Is this checkbox active the red warning lamp will be flashing during an active test.

## 10.11 Adaptive HV timing

Has the device IO-CPU firmware 33284 or newer this checkbox will be displayed.

Is this checkbox active the start of the test will be modified during a high voltage test with AC current.



Normally during the start of the test an intermediate measurement will be done to set the test voltage in respect to the load.

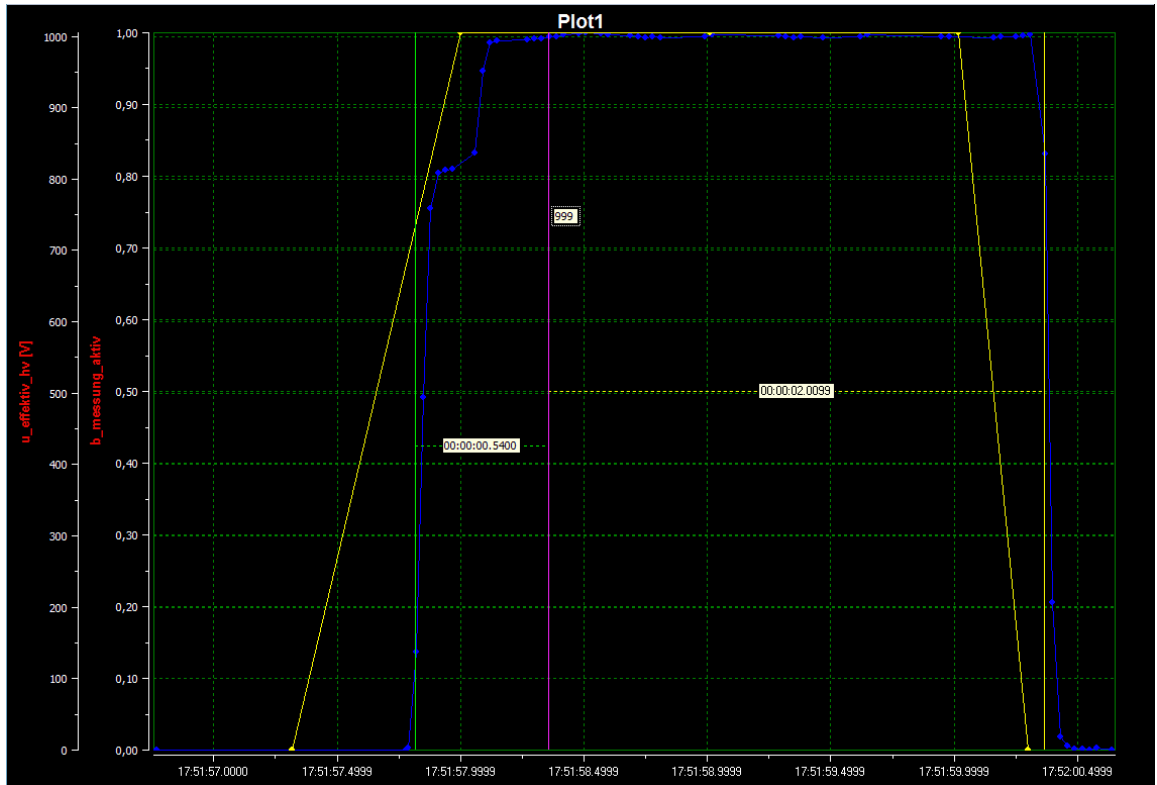

Is the checkbox active it will be recognized that the load between units under test will not change. After 5 units under test with the same load have been measured the intermediate measurement will be omitted.

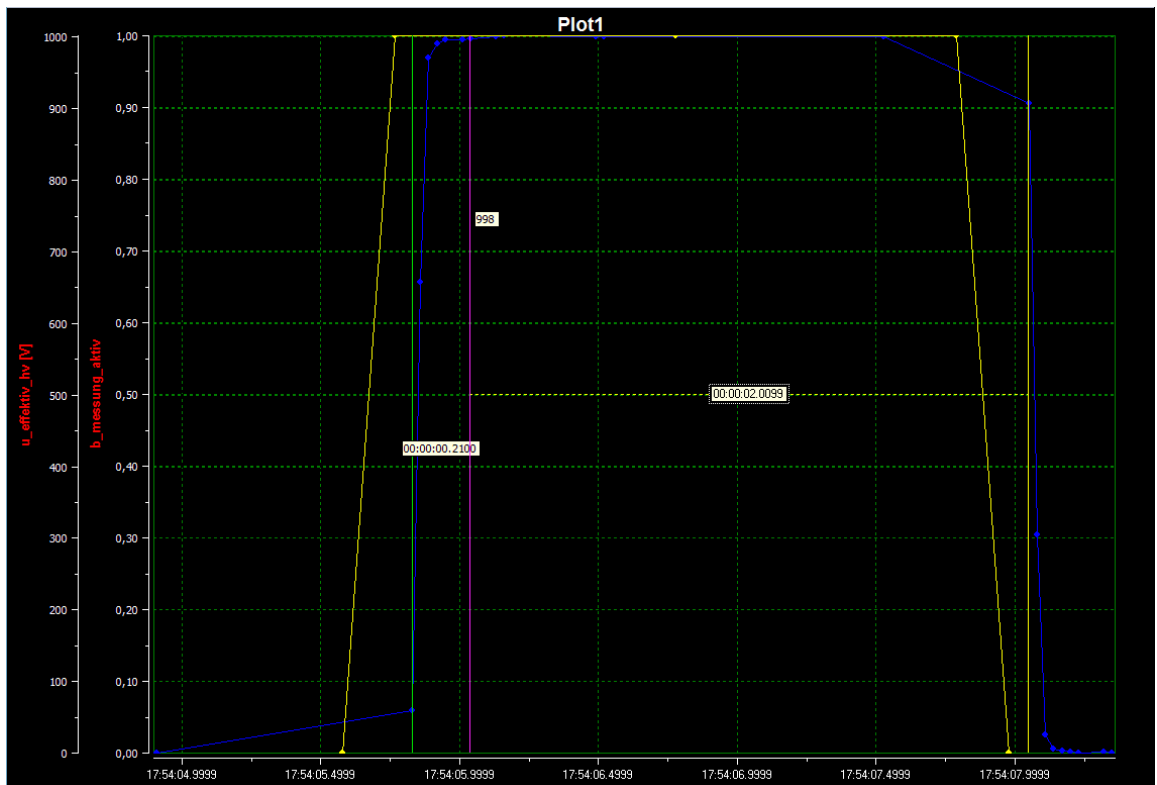

The intermediate measurement gets active again if one of the following cases occurs:

- The nominal voltage has changed.
- The load of the units under test has changed.

### **10.12 Turn off analog output**

This checkbox must be set if the test type Analog output (optional article 202734) is to be used.

This switches off the output of the measurement and result values via the analog interface.

## 11 Technical support

In the case you have questions about the operation of the device contact via email [support@etl-prueftechnik.de](mailto:support@etl-prueftechnik.de). Your request should provide the information as in the example below if possible. The serial number is located on a label on the rear side of the device. You can find the version numbers in **ETL DataView 3** under **Information** -> **Software**. Using your own application you can get them with the appropriate functions.

Dear Supportteam,

I have a question regarding/a problem with the following device:

Order number:

Serial number:

Version ETL Dataview 3:

Version IO-CPU:

Version LT-CPU:

## 12 Technical Data

### 12.1 General Technical Data

<b>General</b>	Power connection:	230 V, 50 Hz / 60 Hz	
	Power consumption:	Max. 10 A, depending on the type up to 16 A	
	Display:	Type X2:	without Display
		Type X4:	TFT-Display with Touch 5,7 inches, 640 x 480
		Type X5:	TFT-Display with Touch 10,4 inches, 800 x 600
		Type X6:	without Display, with VGA-connection
		Type X8:	TFT-Display with Touch 10,4 inches, 800 x 600
	Setting the test parameters:	Manually or fully automatically via interface	
	Programming:	Via display or external control	
	Error signal:	Acoustically, optically or via interface	
	Dimensions (W x H x D):	410 x 210 x 435 mm	
	Weight:	From ca. 18 – 35 kg	
	Casing:	Metal, light grey	
	Temperature range:	5 - 45 °C	
Basic equipment:	Instruction manual, main cable, safety circuit plug		
Calibration:	Factory calibration certificate inclusive		
<b>Interfaces</b>	ETL Interface, digital:	Start, stop, result good / error and test in process, etc.	
	Optional: USER Interface, digital:	Freely configurable IOs	
	Optional: ADF Interface:	Analogue IOs and frequency inputs	
	Remote control interface RS232:	For the connection to the PC and for direct connection to a terminal programme or a log printer	
	CAN:	For the expansion of the test system, for additional features und further expansion stages	
<b>Connections</b>	High voltage outputs:	The contacting of the test object is executed via 2 potential-free high voltage outputs, each double-pole with connection jack for an HVP06C plug.	
	PE Test probe:	Connection for contacting the test objects via a test probe with start push button and result-LEDs.	
	Safety circuit:	For the implementation of the suitable safety circuit according to EN 50191	
	Warning light connection:	For the connection of a warning light combination according to EN 50191	

<b>Starting the Test</b>	Start and stop signal by a test pistol:	Via a special automatic choke and 4-pole technology
	Start button on the device:	Starting the test with a button at the front of the device
	Start and stop signal via interface:	Starting the test via PLC or PC-interface
	Start button via an external switch:	Starting the test via digital IO, e.g. via foot switch
<b>Setup</b>	Keyboard lock:	Individually configurable
	Output options:	Individual configuration of the result outputs
	Buzzer options:	Individual configuration of the acoustic signals
	Start options:	Individual setting of the start mode
	Special functions:	Setting the automatic choke, the series fault and contacting control
	Language and mode selection for an external printer:	English, German, Swedish, Italian, Spanish, Dutch / mode: printout at I.O., not N.I.O. or all the times
	Ramp options:	Ramp time and kind of the ramp decrease
	Test time:	Test time scaling
<b>Test time</b>	Setting range:	0,5 – 6 000 s
	Resolution:	0,01 s

## 12.2 Measurement modules, technical data

The **ATS 400** is a modular instrument and can be combined in a variety of combinations of measuring modules.

The data sheets of the measuring modules are individual documents which can be obtained separately from this document or which were already enclosed with the quotation

**13 Manufacturer's Declaration / EU-Declaration of Conformity**

**Prüfsystem ATS 400 / Test System ATS 400  
(Serie 400 / Series 400)**

**Hersteller**  
*Manufacturer*

**ETL Prüftechnik GmbH**  
**Lembergstraße 23**  
**70825 Korntal-Münchingen**  
**DEUTSCHLAND**

**Dieses Produkt entspricht den nachstehend aufgeführten Richtlinien der Europäischen Union:**  
*This product complies with the following European Union Directives:*

**Niederspannungsrichtlinie**                      **2014/35/EU**  
*Low Voltage Directive*

**EMV-Richtlinie**                                      **2014/30/EU**  
*EMC Directive*

**Zur Überprüfung der Übereinstimmung des Produktes mit diesen Richtlinien wurden folgende harmonisierte Normen angewandt:**

*The following standards were used to verify the compliance with the EU Directives:*

<b>DIN EN 61010-1:2011-07</b>	<b>Sicherheitskreis SHK-NG / Safety control unit:</b>
<b>DIN EN 61326-1:2013-07</b>	<b>EN ISO 13849-1:2015</b>
<b>DIN EN 61000-3-3:2014-03</b>	<b>EN 61508-3:2010</b>
<b>DIN EN 61000-3-2:2015-03</b>	<b>EN 574:1996+A1:2008</b>
<b>DIN EN 50191:2011-10</b>	<b>EN 62061:2005+Cor.:2010+A1:2013+A2:2015</b>

**Aussteller / Declarer:**

**Mathias Braunmiller / Geschäftsführer / General Manager**



**Ort, Datum / Town, date:**                      Korntal, den 12.01.2021



**Rechtsverbindliche Unterschrift:**  
*Legal authorized signature:*

**Mathias Braunmiller / Geschäftsführer / General Manager**



**Diese Erklärung bescheinigt die Übereinstimmung mit den genannten Richtlinien.**  
*This declaration certifies the conformity to the named directives.*

**Die Sicherheitshinweise der mitgelieferten Produktinformationen sind zu beachten.**  
*Observe the safety instructions of the supplied product information and general local safety regulations as you mount and use the product.*

## 14 Warranty

The warranty lasts 24 months from the date of delivery.

Within the period of warranty parts that verifiably have become unusable because of bad material or faulty fabrication are gratuitously overhauled or replaced with free transmittal to us or to a service center named by us.

Avoid self-intervention that might delete your entitlement.

Of course the service center and the manufacturer are at your disposal after the period of warranty as well, so that you are always equipped with faultless test devices.

## 15 Personal Notes



## 16 Appendix A SC-NG error numbers

The following are the error numbers of the safety circuit module. The error number is displayed in **ETL DataView 3** in the field `state machine`.

Error number	Reason	Annotation
0x81	Unknown status in main state machine	Problem in the firmware of the safety circuit module.
0x82	Internal and external status too uneven for a long time	Problem in the firmware of the safety circuit module.
0x83	Reset cause was watchdog	Firmware of the safety circuit board was restarted unintentionally.
0x84	AD conversion timeout	AD conversion took too long.
0x85	Invalid status in switch-block of isFastSwitchOff ()	Problem in the firmware of the safety circuit module.
0x86	Stack-Test	Problem in the firmware of the safety circuit module.
0x87	ROM-Test	Problem in the firmware of the safety circuit module.
0x88	RAM-Test	Problem in the firmware of the safety circuit module.
0x8A	Current configuration too often deviates from Init configuration - MC1	The configuration has changed, e.g. In operation, for example, the safety circuit plug was removed or a cable break occurred.
0x8B	Current configuration too often deviates from Init configuration - MC2	The configuration has changed, e.g. In operation, for example, the safety circuit plug was removed or a cable break occurred.
0x8C	No configuration plug (configuration 0 detected)	There is no configuration plug inserted.
0x90	Initialization: Configuration 1: no switch must be pressed	When switching on or reset, a switch was detected as being pressed. There is a cabling error or the switch is defective.
0x91	Initialization: Configuration 2: Switches must be the same (both open or both closed)	When switching on or reset, a switch was detected as being pressed. There is a cabling error or the switch is defective.
0x92	Initialization: Configuration 3: Switches must be pressed the same (similar to above but 1C10)	When switching on or reset, a switch was detected as being pressed. There is a cabling error or the switch is defective.
0x93	Initialization: Configuration 5: "Start" must not be active at startup	At the start, the safety circuit has already been closed manually.
0x94	Initialization: Configuration 6: Both switches must be pressed the same	Both OSSDs must have the same status. The sending device may be defective.

<b>Error number</b>	<b>Reason</b>	<b>Annotation</b>
0x95	Initialization: Configuration 7: Both switches must be pressed the same or no release_opener	The safety door switches are not actuated the same or the door opener switch is not plausible. There may be a cabling error.
0x96	Initialization: Configuration 8: Both switches must be pressed the same	The safety door switches are not actuated the same or the door opener switch is not plausible. There may be a cabling error.
0x97	Configuration 9: Both switches must be pressed the same	Both OSSDs must have the same status. The sending device may be defective or the door opener switch is not plausible.
0x98	Initialization: Configuration 1: Is E6 connected to O1	Wiring error: E6 is not connected to O1.
0x99	Initialization: Configuration 4: Is E4 connected to O1	Wiring error: E4 is not connected to O1.
0x9A	Initialization: Configuration 5: Are E6, E7, E8 connected to O1	Wiring error: E6, E7 and E8 are not connected to O1.
0x9B	Configuration 6: Input status E5-E7 not equal	The switching states of the two channels of the intelligent switch must be the same.
0x9C	Configuration 9: Input status E4-E5 not equal	The switching states of the two channels of the safety guard must be the same.
0x9F	Invalid switch position in configuration 1	The switches in configuration 1 (two-handed appliance) have an invalid state, ie normally open / normally closed or open together. This can occur when using Safe Balls by the user or one of the switches is defective.
0xA0	Initialization: waits too long to detect a valid configuration	No valid configuration is detected. The cause is a wiring error.
0xA1 – 0xAF	Synchronization problems of the controllers	Problem in the firmware of the safety circuit module.
0xB0	Error at WL1 / state WL1 ON – detected by MC1	Not plausible condition of the warning lamp 1 (red). There may be a wiring problem.
0xB1	Error at WL1 / state WL1 OFF - detected by MC1	Not plausible condition of the warning lamp 1 (red). There may be a wiring problem.
0xB2	Error at WL2 / state WL2 ON - detected by MC1	Not plausible condition of the warning lamp 2 (green). There may be a wiring problem.
0xB3	Error at WL2 / state WL2 OFF - detected by MC1	Not plausible condition of the warning lamp 2 (green). There may be a wiring problem.
0xB4	Error at WL1 / state WL1 ON - detected by MC2	Not plausible condition of the warning lamp 1 (red). There may be a wiring problem.
0xB5	Error at WL1 / state WL1 OFF - detected by MC2	Not plausible condition of the warning lamp 1 (red). There may be a wiring problem.
0xB6	Error at WL2 / state WL2 ON - detected by MC2	Not plausible condition of the warning lamp 2 (green). There may be a wiring problem.
0xB7	Error at WL2 / state WL2 OFF - detected by MC2	Not plausible condition of the warning lamp 2 (green). There may be a wiring problem.
0xBB – 0xBE	Synchronization problems of the controllers	Problem in the firmware or hardware of the safety circuit module.

<b>Error number</b>	<b>Reason</b>	<b>Annotation</b>
0xC0	MC1 - MC2 Different relay status	The relay status on the controllers is different. Maybe a problem in the hardware.
0xC1	Timeout while waiting for new record	No data is received from the baseboard.
0xC2	Configuration "Slave" has changed	Hardware error
0xC3	keine gültige Relaiskonfiguration gefunden	Probably hardware failure of the relays in the current enable circuit.
0xC4 - 0xC5	Relays should be switched / dropped, but not recognized (Normally closed)	Probably hardware failure of the relays in the current enable circuit.
0xCB	No Slave - BB 1 + 2 have switched - an error occurred	Probably hardware failure of the relays in the current enable circuit.
0xCC	Relay state machine too different for too long	
0xCF	Main state machine too long different	
0xD0	MC1: in state D, UeK is open, although door opener is not actuated	Door opener not activated, but ÜK is open, possibly wiring error.
0xD1	MC1: Interlock: Plausibility error: UeK is closed when the safety door is opened (must not be)	Door (SK) is closed but guide lock (ÜK) is open, possibly cabling error.
0xD2	MC1: Interlock-UeK monitoring - cross-circuit with E8	Door opener is energized but ÜK is still closed, possibly wiring error.
0xD3	MC1: The loopback of O1 does not match expectation	
0xD4	MC1: At the start the door opener must not be activated yet.	
0xD5	MC2: in state D, UeK is open, although door opener is not actuated	Door opener not activated, but ÜK is open, possibly wiring error.
0xD6	MC2: Interlock: Plausibility error: with open protective door is UeK closed (may be Not to be)	Door (SK) is closed but tumbler (ÜK) is open, possibly cabling error.
0xD7	MC2: Interlock-UeK monitoring - cross-circuit with E8	Door opener is energized but ÜK is still closed, possibly wiring error.
0xD8	MC2: The loopback of O1 does not match expectation	
0xD9	MC2: At the start the door opener must not be activated yet.	
0xE0	Data from the PIC door opener only allowed in K7, K8, K9 - violated here	Problem in the firmware of the baseboard.

<b>Error number</b>	<b>Reason</b>	<b>Annotation</b>
0xE1	Data from the PIC - START signal only allowed in K5 - violated here	Problem in the firmware of the baseboard.
0xE2	Data from the PIC timeout	There will be no data received from the baseboard. Hardware defect in the baseboard.
0xE3	Data from PIC - Frame Error - Stop bit not HIGH	
0xE4	Data from the PIC - Frame Error - The Unused bits are not LOW	
0xE5	Data from PIC - Frame Error Counter not (correctly) incremented	
0xE6	Data from the PIC - Frame Error - Parity error	
0xE8	Serial interface - Timeout MC1	
0xE9	Serial interface - bit9 does not change MC1	
0xEA	Serial interface - Timeout MC2	
0xEB	Serial interface - bit9 does not change MC2	



---

Lembergstraße 23  
70825 Korntal

Telefon: +49 711 83 99 39-0  
Telefax: +49 711 83 99 39-9  
Internet: [www.etl-prueftechnik.de](http://www.etl-prueftechnik.de)  
E-Mail: [info@etl-prueftechnik.de](mailto:info@etl-prueftechnik.de)